

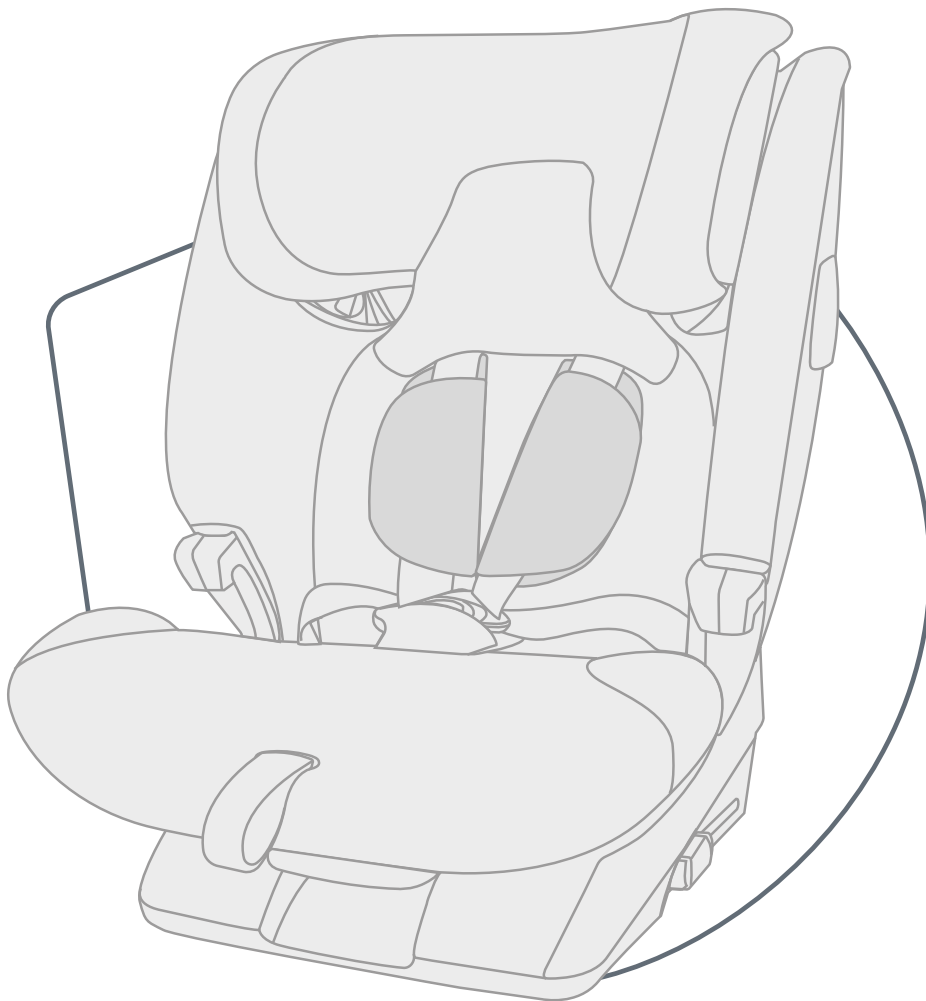

# ADVANSAFIX PRO

USER GUIDE



EN

**BRITAX RÖMER Child Safety EMEA**

[www.britax-roemer.com](http://www.britax-roemer.com) | [contact@britax.com](mailto:contact@britax.com)

# Contents

---

<b>1</b>	<b>Symbol explanation.....</b>	<b>3</b>	<b>7.2</b>	<b>Cover.....</b>	<b>28</b>
<b>2</b>	<b>Safety.....</b>	<b>4</b>	<b>7.3</b>	<b>Shoulder pads.....</b>	<b>29</b>
2.1	User Guide.....	4	<b>7.4</b>	<b>Troubleshooting.....</b>	<b>30</b>
2.2	Intended use.....	4	<b>8</b>	<b>Storage and disposal.....</b>	<b>31</b>
2.3	Misuse.....	4	8.1	Storage.....	31
2.4	Safety informations.....	4	8.2	Disposal.....	31
<b>3</b>	<b>Settings.....</b>	<b>5</b>	<b>9</b>	<b>Contact.....</b>	<b>32</b>
3.1	Adjust headrest.....	5			
3.2	Adjusting the seat angle.....	6			
3.3	SICT.....	6			
3.4	XP-PAD.....	7			
<b>4</b>	<b>Use in the vehicle.....</b>	<b>9</b>			
4.1	Fastening type A and B.....	9			
4.2	Secure child seat A (76 – 105 cm).....	9			
4.3	Loosen child seat A (76 – 105 cm).....	12			
4.4	Secure child seat B1 (100 – 150 cm).....	13			
4.5	Loosen child seat B1 (100 – 150 cm).....	15			
4.6	Secure child seat B2 (100 – 150 cm).....	16			
4.7	Loosen child seat B2 (100 – 150 cm).....	17			
<b>5</b>	<b>Buckling in and unbuckling.....</b>	<b>19</b>			
5.1	Buckle child in A (76 – 105 cm).....	19			
5.2	Check before every journey A (76 – 105 cm)...	19			
5.3	Unbuckle child A (76 – 105 cm).....	20			
5.4	Buckle child in B (100 – 150 cm).....	20			
5.5	Check before every journey B (100 – 150 cm).	21			
5.6	Unbuckle child B (100 – 150 cm).....	21			
<b>6</b>	<b>Changing the fastening type.....</b>	<b>22</b>			
6.1	Changing to fastening type B (100 – 150 cm).	22			
6.2	Changing to fastening type A (76 – 105 cm)...	24			
<b>7</b>	<b>Cleaning and maintenance.....</b>	<b>27</b>			
7.1	Harness buckle.....	27			

# 1 Symbol explanation

---

## Warning signs

Warning signs are used in this user guide in order to advise of potential danger situations. The warning signs inform you about the following items:

- Level of danger,
- Type and source of danger,
- Consequences if disregarded,
- Measures to prevent danger.

Warning signs are shown as follows:

### **WARNING**

#### **Type and source of danger**

Consequences if disregarded

- ▶ Measures to prevent danger

Level of danger	Meaning
DANGER!	Highlights dangerous situations which, if not avoided, lead to serious injuries or death.
WARNING!	Indicates a dangerous situation which, if not avoided, can lead to serious injuries or death.
CAUTION!	Indicates a dangerous situation which, if not avoided, can lead to slight to moderate injuries.
NOTE	Indicates actions that can lead to damage.

## Signs and symbols

---

-  Highlights important information for you.
- 

## Specific actions

- ▶ ...

### **Action**

1. Demands action from you.
2. Defined sequence of actions.
3. ...

### **Result of action**

- ✓ There is where you will find the result of a sequence of actions.

## 2 Safety

### 2.1 User Guide

This user guide is a component of the product and contributes to its safe use. Non-compliance may lead to serious or even fatal injuries. If there are uncertainties, do not use the product and immediately contact your retailer.

- ▶ Read the operating instructions.

### 2.2 Intended use

This product has been designed, tested and approved corresponding to the requirements of UN R129/03.

This product is designed for securing a child in a vehicle.

The product is approved for the following details:

Designation	Value
Body height	From 15 months <b>and</b> 76 – 150 cm
Body weight	≤ 22 kg

Use the product on forward-facing car seats.

This approval is invalidated if you make any modifications to this product. Changes may only be made by the manufacturer. The stickers on the product are an important component of the product.

- ▶ Do not make any changes to the product.
- ▶ Do not remove any stickers from the product.

### 2.3 Misuse

- ▶ Do not use the product as a toy.
- ▶ Do not use the product as a chair outside the vehicle, not even to test.
- ▶ Only secure the child seat with fastening points described in these operating instructions.
- ▶ Never secure the product with a 2-point seat belt.
- ▶ Ensure that the product is not trapped between hard objects (car door, seat rails, etc.).
- ▶ Keep product away from moisture, wet conditions, liquids, dust and salt spray.
- ▶ Do not lean heavy objects on the product.
- ▶ Never lubricate or oil parts of the product.
- ▶ Sensitive car seat covers may be damaged. Use the Britax Römer child seat base. These are available separately.

### 2.4 Safety informations

#### Risk of injury from damaged child seat

In the event of an accident at a collision speed of more than 10 km/h, the child seat may be damaged without the

damage being immediately visible. Serious injuries may result from another accident.

- ▶ Replace the product after an accident.
- ▶ Have a damaged product inspected (even if it has fallen onto the ground).
- ▶ Regularly check all the important parts for damage.
- ▶ Ensure that all mechanical components work properly.

#### Risk of burns from hot components

Components of the product may become hot in direct sunlight. Children's skin is sensitive and maybe harmed as a result.

- ▶ Protect the product against intensive direct sunlight when not in use.

#### Risk of injury during use

The temperature in a vehicle can rise dangerously quickly. In addition, it is dangerous to leave the vehicle on the side facing the street.

- ▶ Never leave the child unsupervised in the vehicle.
- ▶ Only secure and remove the child seat from the foot-path-side.

#### Risk of injury from unsecured objects

In case of an emergency stop or accident, unsecured objects or people may cause injury to other occupants in the vehicle.

- ▶ Only fasten the product as described in this user guide.
- ▶ Secure backrests of the car seat (e.g. engage foldable rear).
- ▶ Fasten or remove all heavy or sharp-edged objects in the vehicle (e.g. on the parcel shelf).
- ▶ Ensure that everyone in the vehicle has their seatbelts fastened.
- ▶ Ensure that the product is always secured when it is in the vehicle, even if no child is being transported.

# 3 Settings

## 3.1 Adjust headrest

**i** The headrest setting depends on the type of securing (see "Fastening type A and B", page 9).

### 3.1.1 Set headrest A (76 – 105 cm)

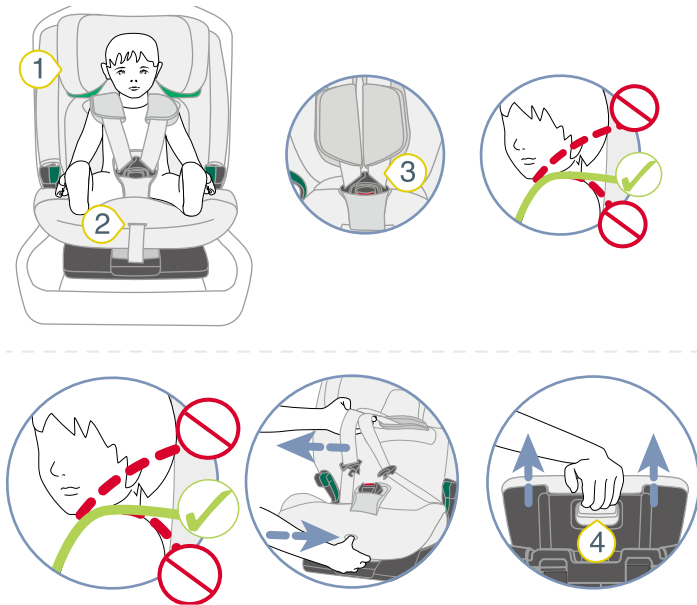

- ① Headrest
- ③ Shoulder straps
- ② Adjustment button
- ④ Release button

1. Check that the headrest **1** is adjusted to the size of the child.

**i** If the exit for the shoulder straps is at the shoulder height of the child, the headrest is positioned correctly. A difference of up to 3 cm is permitted. However, Britax Römer recommends positioning the exit of the shoulder straps at the shoulder height of the child.

► If the headrest is **not** positioned correctly, perform the following steps.

2. To loosen the belt, press the adjustment button **2** and pull both shoulder straps **3** forwards at the same time.

**i** The shoulder pads are **not** connected to the shoulder straps. If you pull on the shoulder pads, the belt is **not** loosened. Only pull on the shoulder straps.

3. Keep the release button **4** pressed and slide the headrest **1** to the correct shoulder height.

4. Check that the headrest **1** is locked correctly in place by pushing the headrest **1** down.

✓ Headrest **1** is adjusted to the size of the child.

✓ Headrest **1** is locked in place.

### 3.1.2 Set headrest B (100 – 150 cm)

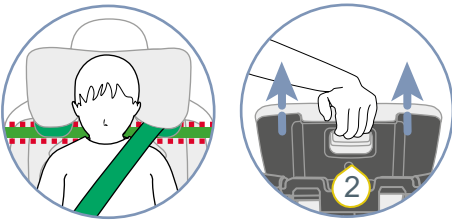
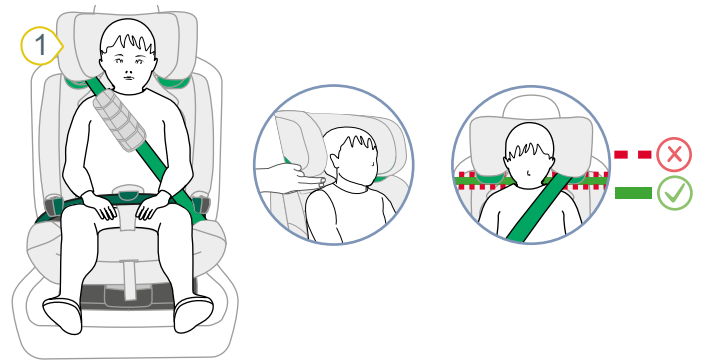

- ① Headrest
- ② Release button

**i** The headrest has a lock. This lock corresponds to a height of approx. 125 cm. You can unlock the upper area from approx. 125 cm to 150 cm (see "Unlock upper area", page 5).

1. Check that the headrest **1** is adjusted to the size of the child.

**i** If the headrest is two finger-widths above the shoulder height of the child, the headrest is positioned correctly.

► If the headrest is not positioned correctly, perform the following steps.

2. Keep the release button **2** pressed and slide the headrest **1** to the correct shoulder height.

3. Check that the headrest **1** is locked correctly in place by pushing the headrest **1** down.

✓ Headrest **1** is adjusted to the size of the child.

✓ Headrest **1** is locked in place.

### 3.1.3 Unlock upper area

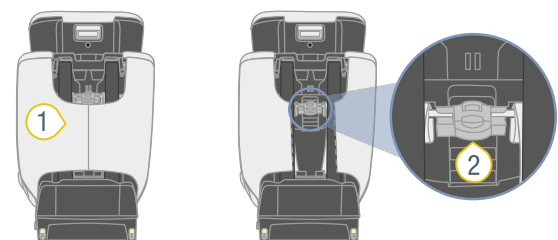

- ① Pocket
- ② Switch

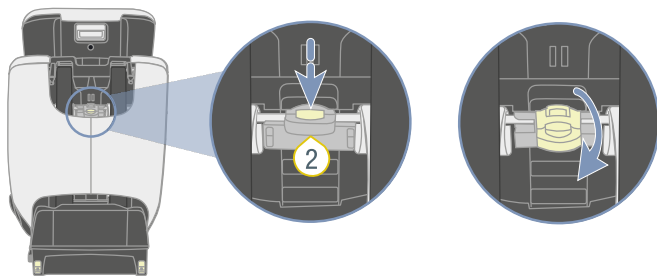

1. Extend the headrest to its maximum.
  2. Keep holding the button on the switch **2** depressed.
  3. Tilt the switch **2** up.
- ✓ Switch **2** is locked in the upper position.

ⓘ The headrest can be set to body sizes of between approx. 125 cm and 150 cm (see "Adjust headrest", page 5).

### 3.2 Adjusting the seat angle

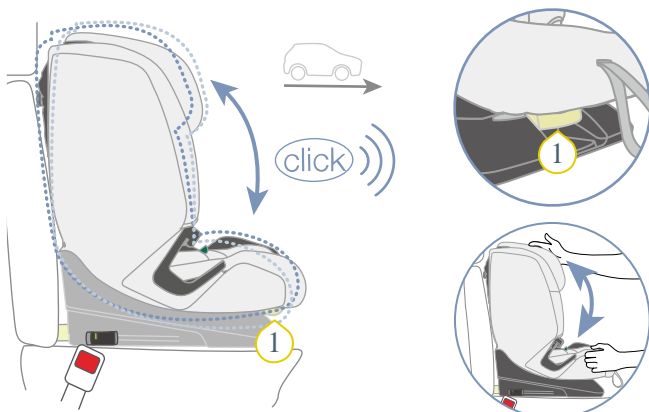

- ⓘ Adjustment button

ⓘ The seat can be used at different angles.

1. Pull the adjustment button **1** forwards and slide the seat to the desired position.
- ✓ The seat audibly locks.
2. Check that the seat is locked in place by pulling it.

ⓘ For fastening types **B1** and **B2** the following shall apply (see "Fastening type A and B", page 9):  
If you change the angle of the seat, the seat belt may slacken. Make sure that the seat belt is taut.

### 3.3 SICT

ⓘ The SICT (Side Impact Cushion Technology) reduces the forces affecting the child in the event of a side impact. The protective effect of the SICT element is greater, the closer it is to the car door.

ⓘ The SICT element is independent of the type of fastening. For simplicity, the following illustrations show fastening type A.

#### 3.3.1 Secure SICT element

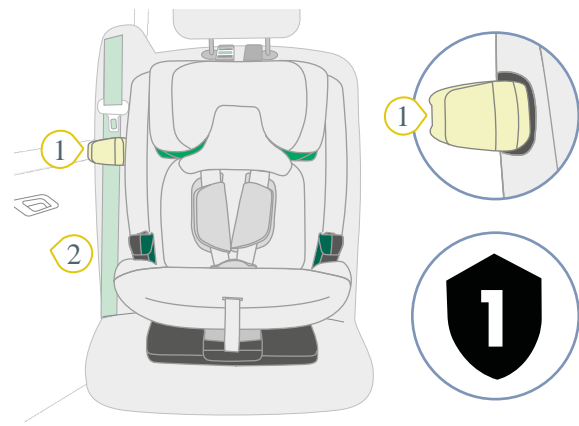

- ⓘ SICT element      ⓘ Car door

1. Place the SICT element **1** to the side of the child seat.

ⓘ Select the side of the child seat closest to the car door.  
The **sign symbol** with number **1** on the SICT element faces the **sign symbol** of the SICT fastening point on the child seat.

2. Slide the SICT element **1** onto the SICT fastening point.
3. Check the distance between the SICT element **1** and the car door **2**.

#### NOTE

##### Material damage as a result of SICT element

In rare cases, the space between the car seat and the car door is so small that the SICT element touches the car door. The car door may be scratched when it is closed.

- Carefully close the car door.
- Make sure that the SICT element **does not** touch the car door.
- **Do not** close the car door fully if the SICT element is touching the car door.

4. If the SICT element **1** is touching the car door **2**, reduce the distance of the SICT element **1** (see "Reduce distance", page 7).

ⓘ If the SICT element is **not** touching the car door, **no** further steps are necessary.

### 3.3.2 Reduce distance

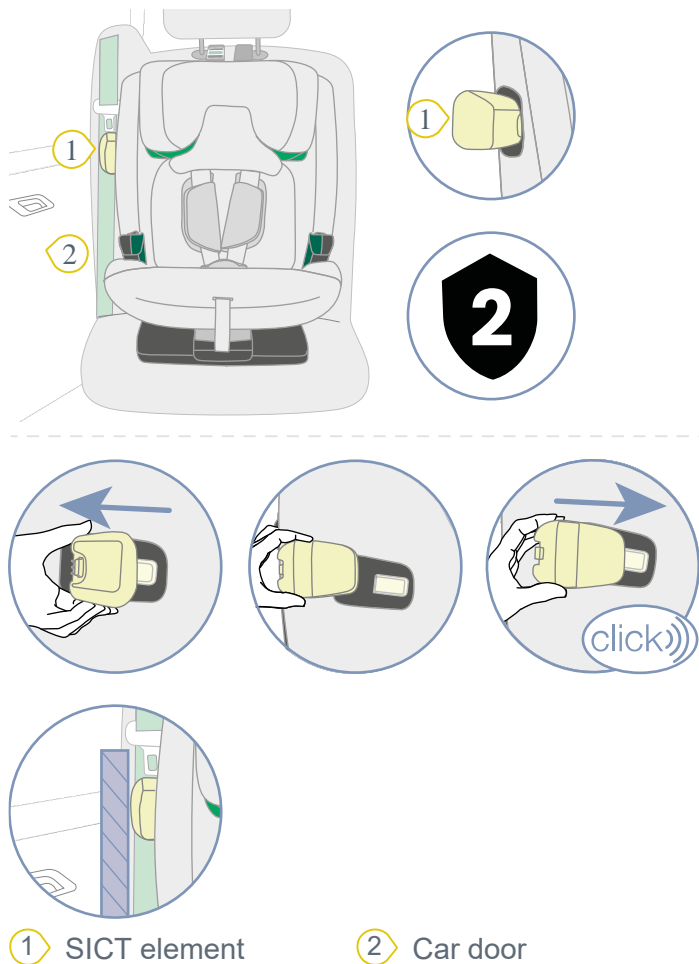

- Slide the SICT element 1 from the SICT fastening point.
  - ⓘ You need a relatively large amount of force to remove the SICT element from the child seat. Place the SICT element close to the child seat.
- Place the SICT element 1 to the side of the child seat.
  - ⓘ The **sign symbol** with number 2 on the SICT element faces the **sign symbol** of the SICT fastening point on the child seat.
- Slide the SICT element 1 onto the SICT fastening point.
- Check the distance between the SICT element 1 and the car door 2.

#### NOTE

##### Material damage as a result of SICT element

In rare cases, the space between the car seat and the car door is so small that the SICT element touches the car door. The car door may be scratched when it is closed.

- Carefully close the car door.
- Make sure that the SICT element **does not** touch the car door.
- **Do not** close the car door fully if the SICT element is touching the car door.

- If the SICT element 1 is still touching the car door 2, remove the SICT element (see "Remove SICT element", page 7).

ⓘ If the SICT element is **not** touching the car door, no further steps are necessary.

### 3.3.3 Remove SICT element

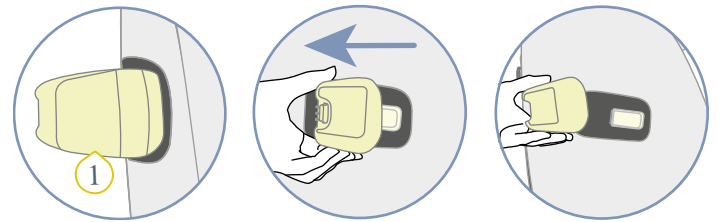

- Do not use the SICT element 1 on the selected car seat.
- Slide the SICT element 1 from the SICT fastening point.

ⓘ You need a relatively large amount of force to remove the SICT element from the child seat. Place the SICT element close to the child seat.

- Stow the SICT element 1.
- Note the storage instructions (see "Storage", page 31).

### 3.4 XP-PAD

ⓘ The XP-PAD reduces the forces affecting on the child's spine during an accident.

ⓘ The XP-PAD may only be used for fastening types B1 and B2. (see "Fastening type A and B", page 9).

ⓘ The child seat is approved for use both with and without the use XP-PAD. This user guide describes how to fasten the child with the XP-PAD. If there are any questions, please get in touch (see "Contact", page 32).



### 3.4.1 Secure XP-PAD

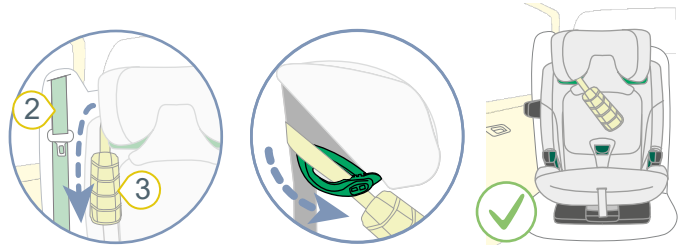
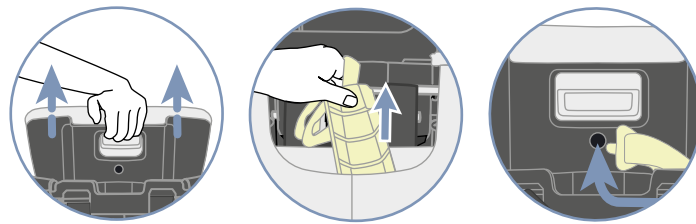
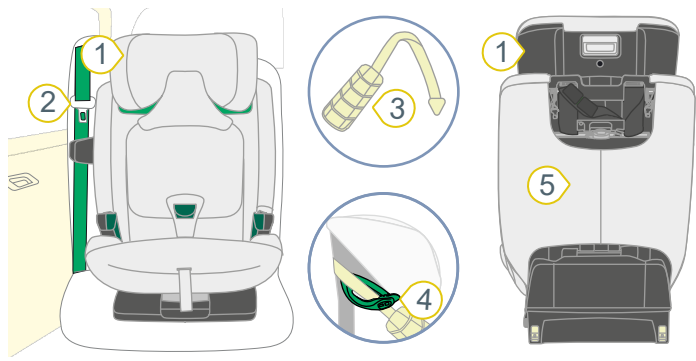

- ① Headrest
- ② 3-point seat belt
- ③ XP-PAD
- ④ Light-green belt holder
- ⑤ Pocket

1. Pull the headrest 1 as far up as possible.
2. Remove the XP-Pad 3 from the pocket 5.
3. Fasten the XP-Pad 3 to the back of the headrest.
4. Place the XP-Pad 3 on the side of the seat belt 2.
5. Pass the tape of the XP-Pad 3 into the light green belt holder 4.
6. Make sure that the tape is fully and untwisted in the belt holder 4.

### 3.4.2 Remove XP-PAD

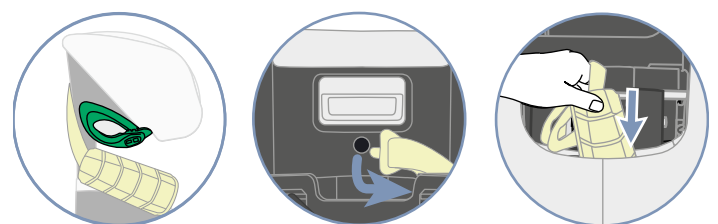
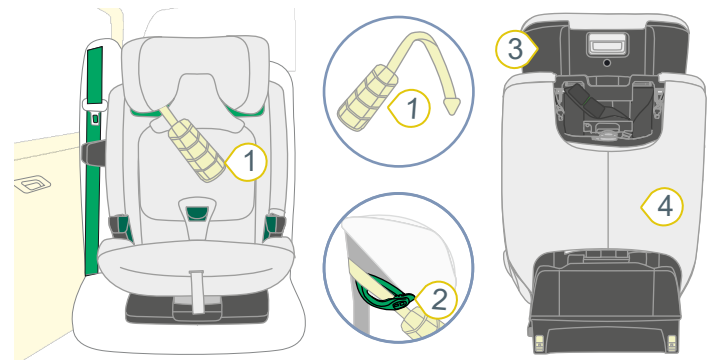

- ① XP-PAD
- ② Light-green belt holder
- ③ Headrest
- ④ Pocket

1. Pass the tape of the XP-Pad 1 out of the light-green belt holder 2.
2. Remove the XP-Pad 1 from the back of the headrest 3.
3. Stow the XP-Pad 1 in the pocket 4.



# 4 Use in the vehicle

## 4.1 Fastening type A and B

**i** This child seat is approved for children with height from 76 cm to 150 cm. So that the child is optimally secured, there are two types of fastening, **A** and **B**. Each fastening type has been developed for a defined size range. Secure the child seat corresponding to the size of the child to be secured.

Size of the child	Fastening type
76 cm - 105 cm	<b>A</b>
From 15 months	
Maximum weight 22 kg	
100 cm - 150 cm	<b>B</b>

**i** This product is supplied with the configuration for fastening type **A**. If you want to use fastening type **B**, you have to change the fastening type (see "Changing the fastening type", page 22).

### 4.1.1 Fastening type A (76 – 105 cm)

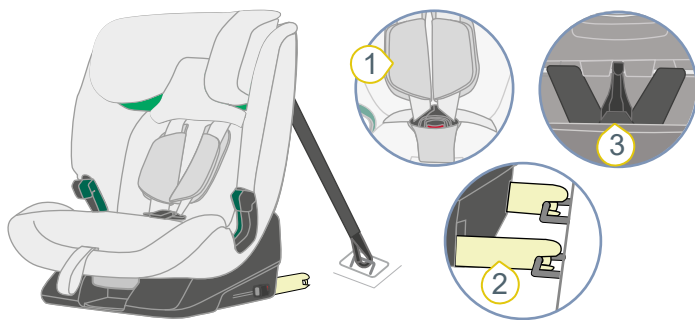

- ① 5-point harness
- ② ISOFIX
- ③ TopTether

With fastening type **A**, the child is secured in the child seat with a 5-point seat belt **1**. The child seat is secured to the car seat with ISOFIX **2** and TopTether **3**.

### 4.1.2 Fastening type B (100 – 150 cm)

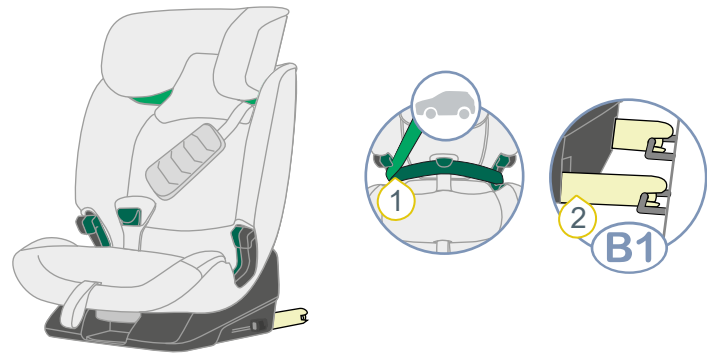

- ① 3-point seat belt
- ② ISOFIX

With fastening type **B**, the child is secured in the child seat with a 3-point seat belt **1**. If the car is fitted with ISOFIX **2**, you can secure the child seat with ISOFIX **2** as well.

Fastening type	Design
<b>B1</b>	3-point seat belt and ISOFIX
<b>B2</b>	3-point seat belt

**i** Britax Römer recommends fastening type **B1**.

## 4.2 Secure child seat A (76 – 105 cm)

### 4.2.1 Select seat

1. Select a suitable seat.
  - Car seats with i-Size approval are suitable.
  - i** In rare cases, the child seat on car seats with i-Size approval can only be adjusted within limits.
  - Suitable car seats with ISOFIX installation bracket, which have been tested and approved by us. You can find these in our model list at [www.britax-roemer.com](http://www.britax-roemer.com).
  - Only car seats arranged in the direction of travel are approved for use.

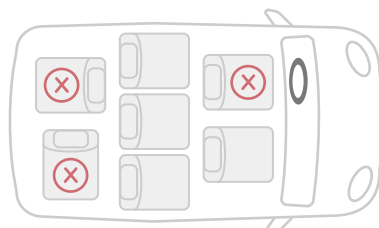

2. Note and observe the vehicle handbook.

**i** Britax Römer recommends positioning the car seats as follows.

**When using on the front seat:**

- ▶ Slide the front seat as far back as possible.

**When using on the rear seat:**

- ▶ Slide the back seat as far back as possible.
- ▶ Slide the front seat as far forwards as possible.

### 4.2.2 Attach insertion aids

**i** The insertion aids simplify connecting the ISOFIX locking arms of the child seat to the ISOFIX installation bracket on the car seat. Some vehicles already have integrated insertion aids. Check whether your vehicle already has the required insertion aids. If the vehicle does not have them, Britax Römer recommends using the insertion aids. These are included in the scope of delivery of the child seat.

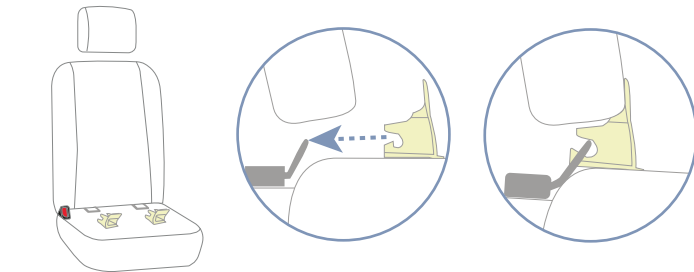
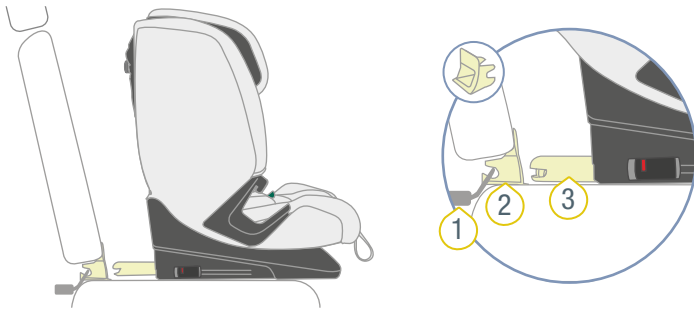

**1** ISOFIX installation bracket      **3** ISOFIX locking arms bracket

**2** Insertion aid

- ▶ Clamp the two insertion aids **2**, with the cut-out facing up, to the ISOFIX installation bracket **1** of the car seat.

**i** For car seats with foldable backrests, the insertion aids **2** must be removed before folding the backrest.

### 4.2.3 Prepare TopTether

#### **⚠ WARNING**

**Risk of injury from unsecured TopTether**

The fastening of the child seat is guaranteed if the TopTether is secured with an approved TopTether anchor point with the snap hook. Not doing this can lead to serious or fatal injuries.

- ▶ Only use anchor points approved for TopTether by the vehicle manufacturer.
- ▶ **Never** use luggage hooks to secure the TopTether.
- ▶ Note and follow vehicle handbook.
- ▶ Anchor points for TopTether are marked in the vehicle with the following symbol.



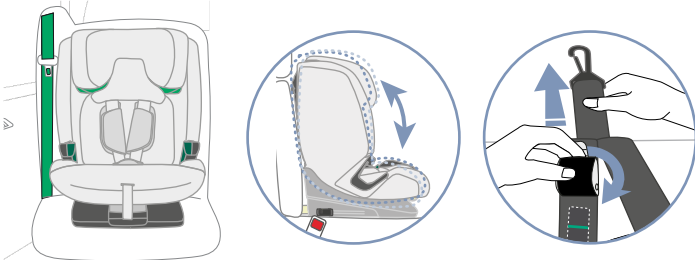
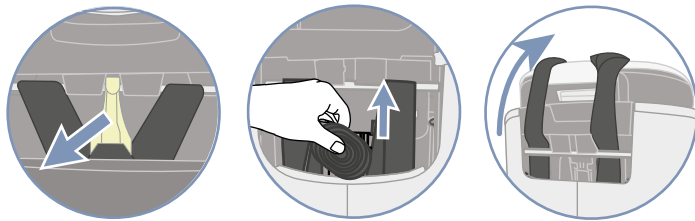
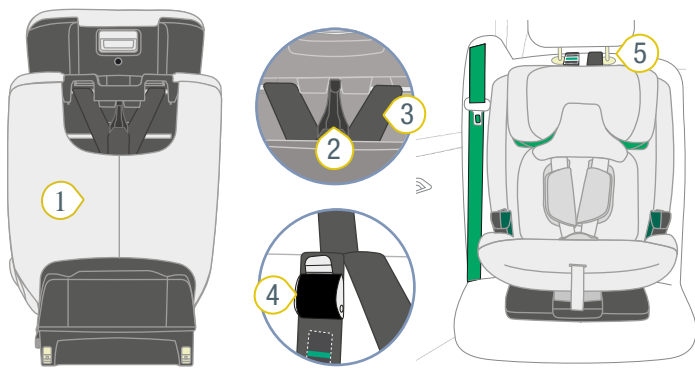

- ① Pocket
- ② Snap hooks
- ③ Belt
- ④ Metal tongue
- ⑤ Bar of the vehicle headrest
- ⑥ Anchor point

1. Hang the snap hook 2 of the TopTether from the rear of the child seat.
2. Take the belt 3 from the pocket 1.
3. Place the belt 3 across the child seat.
4. Place the child seat on the selected car seat in the direction of travel.
5. Adjust the angle of the backrest to the car seat.
  - ⓘ The gap between car seat and child seat should be as small as possible.
6. Extend the belt 3 by pushing the metal tongue 4 from belt 3 and pulling on the snap hook 2.
7. Pass the snap hook 2 centrally between the bars of the vehicle headrest 5.
  - ⓘ If the headrest is integrated in the car seat, pass the snap hook and the belt past the headrest. Use the side closer to the anchor point of the vehicle.
8. Hook the snap hook 2 into the vehicle's anchor point 6.

ⓘ Depending on the vehicle, the anchor point is on the car seat or in the boot, for example. Note and observe the vehicle handbook.

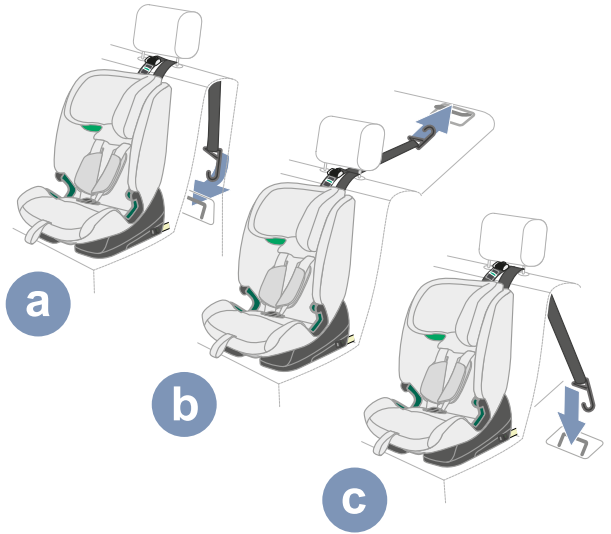

- ✓ The snap hook 2 is secured with the anchor point.
- ✓ The TopTether is ready.

#### 4.2.4 Fastening the ISOFIX

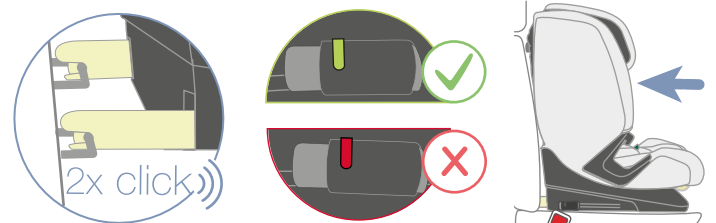
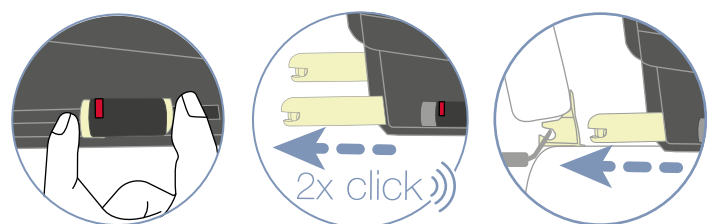
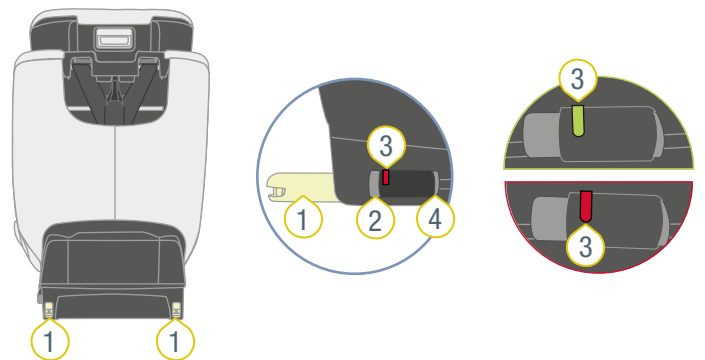

- ① ISOFIX locking arms
- ② Release button
- ③ ISOFIX indicator
- ④ Fastening button

1. Press the locking button 4 and the release button 2 together and slide the ISOFIX locking arm 1 out as far as possible.

- ✓ The ISOFIX locking arm 1 audibly locks in place.
- 2. Slide out the second ISOFIX locking arm 1 as far as possible, as well.
- ✓ The second ISOFIX locking arm 1 audibly locks in place.
- ✓ Both ISOFIX locking arms 1 are extended to the maximum.
- 3. Connect the ISOFIX locking arms 1 to the ISOFIX installation bracket on the car seat.

① The ISOFIX locking arms can be retracted if they are locked in the ISOFIX installation brackets of the car seat.

- ✓ Both ISOFIX locking arms 1 audibly lock in place.
- ✓ Both ISOFIX indicators 3 are green.

**⚠ WARNING** Risk of injury from unsecured child seat. Make sure that both ISOFIX locking arms are fully locked in place. Both ISOFIX indicators must be green.

- 4. Clamp the ISOFIX connection by forcefully pushing the child seat into the backrest of the car seat.

**INFO** The better the clamp, the more the child will be protected.

- 5. Increase the tension of the ISOFIX connection by forcefully pushing forwards on the product.

**INFO** We recommend pushing the product alternately to the left and right.

- 6. Check that the ISOFIX locking arms 1 are in the same position.

① The positions of the ISOFIX locking arms are shown on the product using numbers. These numbers are located above the ISOFIX indicators. Both ISOFIX indicators must show the same number.

- 7. Check that the ISOFIX locking arms 1 are connected to the ISOFIX installation brackets on both sides by pulling at the child seat.

- ✓ If neither of the ISOFIX locking arms 1 comes loose, they are both connected to the vehicle.

#### 4.2.5 Tighten TopTether

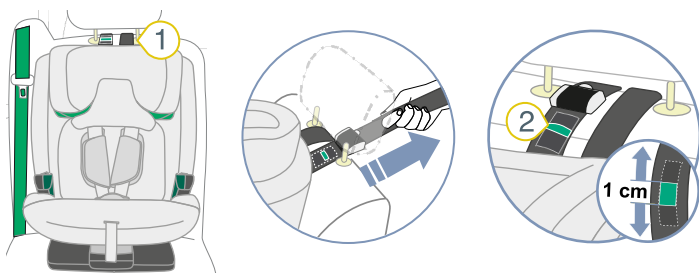

- 1. Make sure that the TopTether 1 is not trapped between the child seat and the car seat.

- 2. Tighten the TopTether 1 by pulling on the belt.

**INFO** Tighten the TopTether 1 until the indicator of the TopTether 2 shows a finger-width of green.

#### 4.2.6 Secure SICT element

- ▶ Secure the SICT element (see "SICT", page 6).

### 4.3 Loosen child seat A (76 – 105 cm)

#### **⚠ WARNING**

##### Risk of injury from unsecured objects

In the case of an emergency stop or accident, the unsecured child seat may cause injury to other occupants in the vehicle.

- ▶ Ensure that the child seat product is always secured when it is in the vehicle, even if no child is being transported.

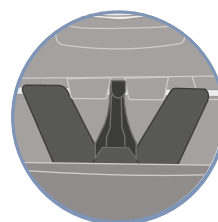
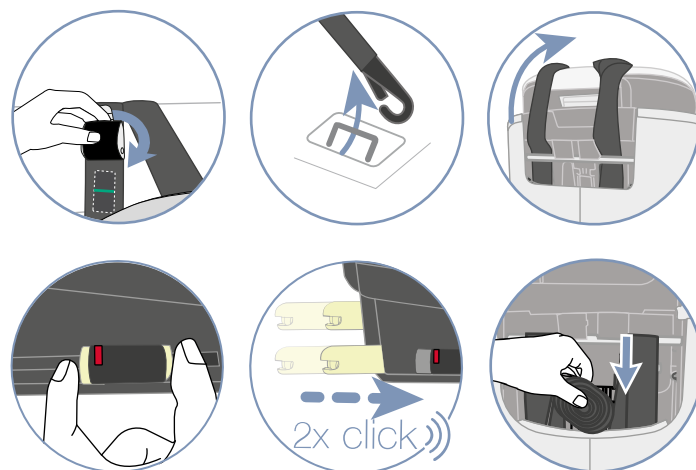
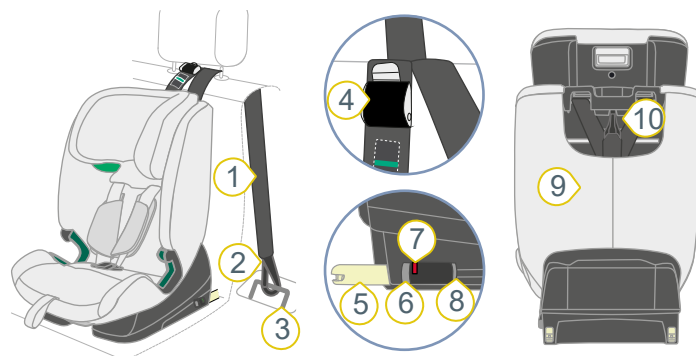

- ① Belt
- ② Snap hooks
- ③ Anchor point
- ④ Metal tongue
- ⑤ ISOFIX locking arms
- ⑥ Release button
- ⑦ ISOFIX indicator
- ⑧ Fastening button
- ⑨ Pocket
- ⑩ Fastening

1. Loosen the TopTether by pushing the Metal tongue **4** away from the belt **1**.
2. Hook the snap hook **2** from the vehicle's anchor point **3**.
3. Place the TopTether facing forwards over the child seat.
4. Press the locking button **8** and the release button **6** together and slide the ISOFIX locking arm **5** back into the bottom section of the seat.

ⓘ If the release button cannot be pressed, the ISOFIX locking arm is not locked in place. Pull the seat.

5. Slide the second ISOFIX locking arm **5** back into the bottom section of the seat as well.
- ✓ Both ISOFIX locking arms and the vehicle are protected against damage.
6. Stow the belt **1** of the TopTether in the pocket **9**.
  7. Hook the snap hook **2** of the TopTether into the fastening **10**.

## 4.4 Secure child seat B1 (100 – 150 cm)

### 4.4.1 Prepare child seat

- ⓘ This product is supplied with the configuration for fastening type **A**. If you want to use fastening type **B**, you have to change the fastening type (see "Changing the fastening type", page 22).

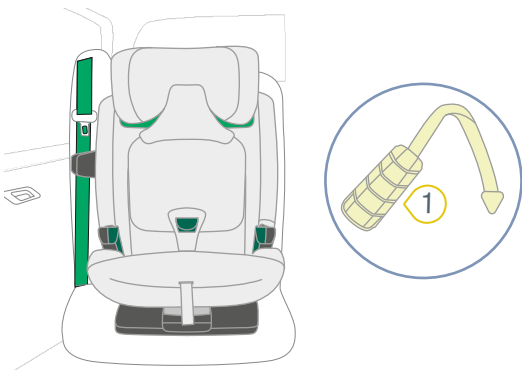

① XP-PAD

- ▶ Make sure that the child seat is ready for the fastening type **B** (see "Changing the fastening type", page 22).
- ▶ Fasten the XP-Pad **1** to the child seat ("XP-PAD").

### 4.4.2 Select seat

1. Select a suitable seat.
    - Car seats with i-Size approval are suitable.
- ⓘ In rare cases, the child seat on car seats with i-Size approval can only be adjusted within limits.

- Suitable car seats with ISOFIX installation bracket, which have been tested and approved by us. You can find these in our model list at [www.britax-roemer.com](http://www.britax-roemer.com).
- Only car seats arranged in the direction of travel are approved for use.

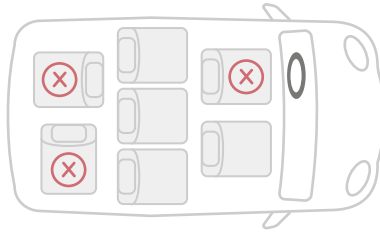

2. Note and observe the vehicle handbook.

- ⓘ Britax Römer recommends positioning the car seats as follows.

#### When using on the front seat:

- ▶ Slide the front seat as far back as possible.

#### When using on the rear seat:

- ▶ Slide the back seat as far back as possible.
- ▶ Slide the front seat as far forwards as possible.

### 4.4.3 Attach insertion aids

- ⓘ The insertion aids simplify connecting the ISOFIX locking arms of the child seat to the ISOFIX installation bracket on the car seat. Some vehicles already have integrated insertion aids. Check whether your vehicle already has the required insertion aids. If the vehicle does not have them, Britax Römer recommends using the insertion aids. These are included in the scope of delivery of the child seat.

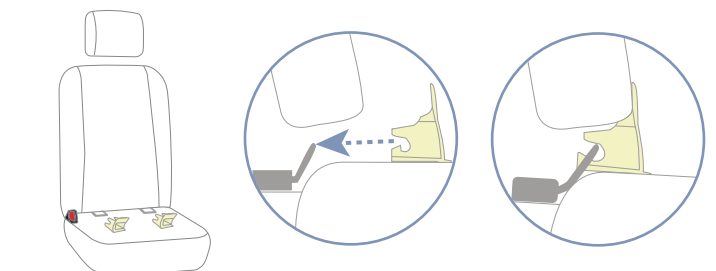
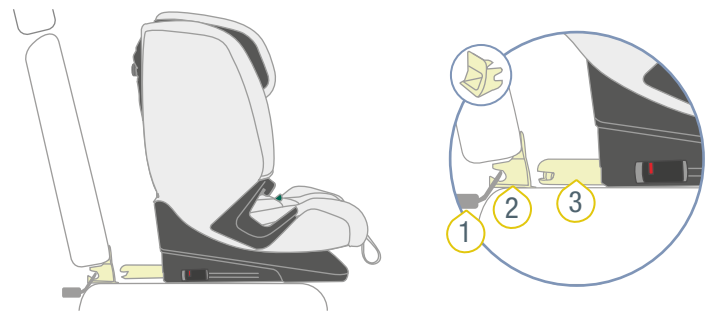

- ① ISOFIX installation bracket  
 ② Insertion aid  
 ③ ISOFIX locking arms



- ▶ Clamp the two insertion aids **2**, with the cut-out facing up, to the ISOFIX installation bracket **1** of the car seat.

- ⓘ For car seats with foldable backrests, the insertion aids **2** must be removed before folding the backrest.

#### 4.4.4 Fastening the ISOFIX

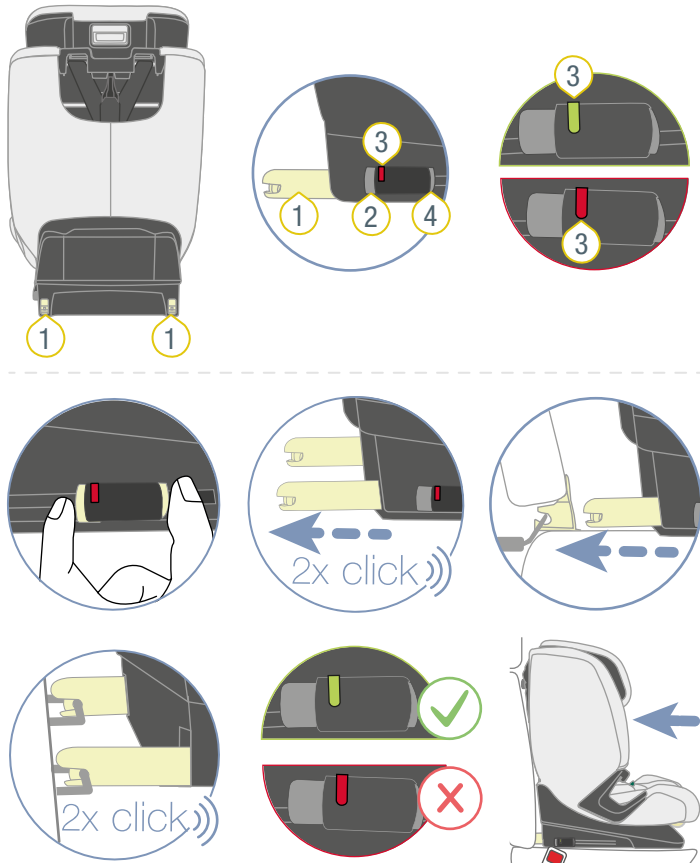

- ① ISOFIX locking arms      ③ ISOFIX indicator
- ② Release button          ④ Fastening button

1. Press the locking button **4** and the release button **2** together and slide the ISOFIX locking arm **1** out as far as possible.
  - ✓ The ISOFIX locking arm **1** audibly locks in place.
2. Slide out the second ISOFIX locking arm **1** as far as possible, as well.
  - ✓ The second ISOFIX locking arm **1** audibly locks in place.
  - ✓ Both ISOFIX locking arms **1** are extended to the maximum.
3. Connect the ISOFIX locking arms **1** to the ISOFIX installation bracket on the car seat.

- ⓘ The ISOFIX locking arms can be retracted if they are locked in the ISOFIX installation brackets of the car seat.

- ✓ Both ISOFIX locking arms **1** audibly lock in place.
- ✓ Both ISOFIX indicators **3** are green.

**⚠ WARNING** Risk of injury from unsecured child seat. Make sure that both ISOFIX locking arms are fully locked in place. Both ISOFIX indicators must be green.

4. Clamp the ISOFIX connection by forcefully pushing the child seat into the backrest of the car seat.

**INFO** The better the clamp, the more the child will be protected.

5. Increase the tension of the ISOFIX connection by forcefully pushing forwards on the product.

**INFO** We recommend pushing the product alternately to the left and right.

6. Check that the ISOFIX locking arms **1** are in the same position.

- ⓘ The positions of the ISOFIX locking arms are shown on the product using numbers. These numbers are located above the ISOFIX indicators. Both ISOFIX indicators must show the same number.

7. Check that the ISOFIX locking arms **1** are connected to the ISOFIX installation brackets on both sides by pulling at the child seat.

- ✓ If neither of the ISOFIX locking arms **1** comes loose, they are both connected to the vehicle.

#### 4.4.5 Secure SICT element

- ▶ Secure the SICT element (see "SICT", page 6).

#### 4.4.6 Secure seat belt

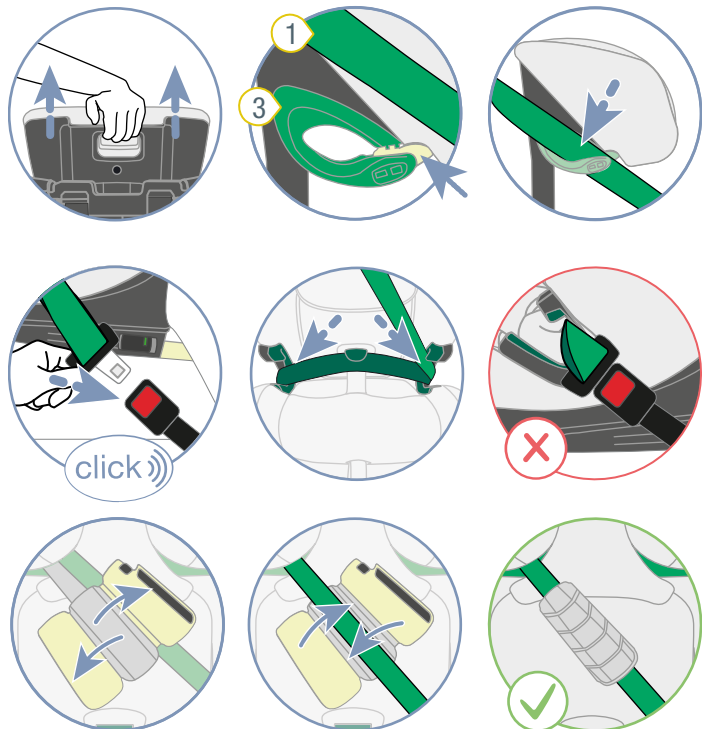
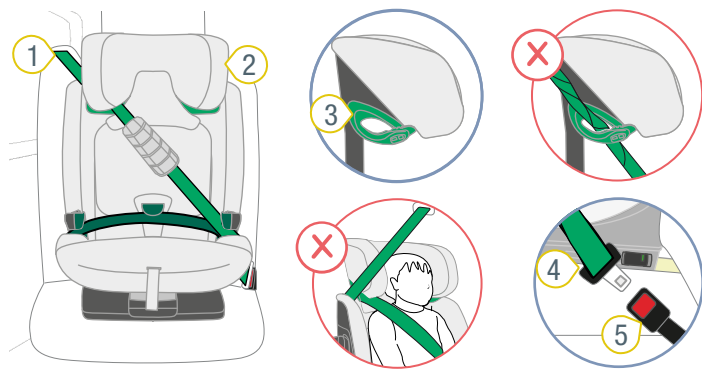

- ① Diagonal belt
- ② Headrest
- ③ Light-green belt holder
- ④ Buckle tongue
- ⑤ Seat belt lock

1. Set the headrest **2** to the highest position.
2. Open the light-green belt holder **3**.
3. Pass the diagonal belt **1** through the light-green belt holder **3** of the headrest **2**.
  - ⚠ **WARNING** Risk of injury if belt fitted incorrectly. The diagonal belt must face away from the alignment of the child seat. Other belt routes impair the protective effect.
    - ▶ Check the belt route.
    - ▶ Make sure that diagonal belt faces against the direction of the child seat.
    - ▶ Do **not** use the child seat on the car seat if the belt route faces forwards.
4. Engage the buckle tongue **4** in the seat belt lock **5**.
5. Place the lap belt in both dark green belt guides.
6. Place the diagonal belt **1** on the side of the seat belt lock **5** into the dark green belt guide.

⚠ **WARNING** Risk of injury if forces are transferred incorrectly.

- ▶ Check the position of the seat belt lock.
- ▶ Do **not** use the child seat on the car seat if the seat belt lock is in the area of the dark green belt guide.

7. Undo the Velcro on the XP-PAD.
8. Fold the top part of the XP-PAD to the side.
9. Insert the diagonal belt **1** into the nubby surface of the XP-PAD.
10. Close the XP-PAD again by refolding the folded-back part and closing the Velcro.

#### 4.5 Loosen child seat B1 (100 – 150 cm)

### ⚠ **WARNING**

#### Risk of injury from unsecured objects

In the case of an emergency stop or accident, the unsecured child seat may cause injury to other occupants in the vehicle.

- ▶ Ensure that the child seat product is always secured when it is in the vehicle, even if no child is being transported.



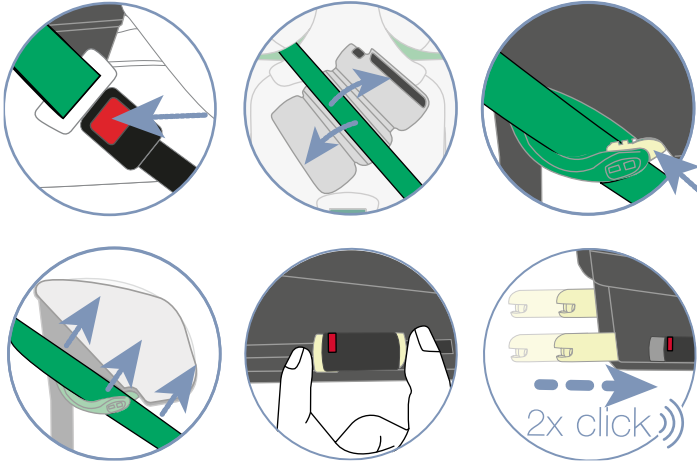
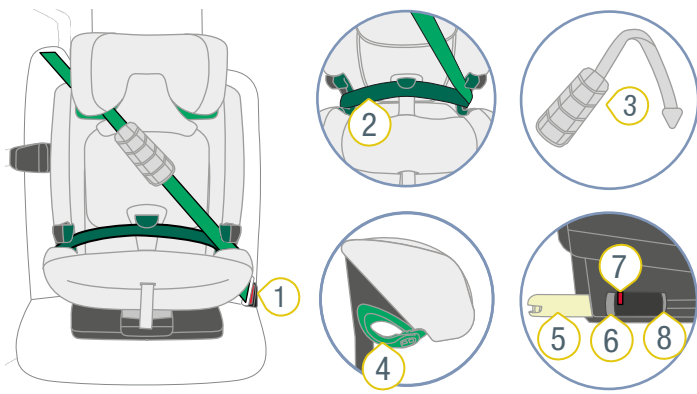

- ① Seat belt lock
- ② 3-point seat belt
- ③ Light-green belt holder
- ④ ISOFIX locking arms
- ⑤ Release button
- ⑥ ISOFIX indicator
- ⑦ Fastening button
- ⑧ XP-PAD

1. Release the 3-point seat belt 2 by pressing the release button on the seat belt lock 1.
2. Open the XP-Pad 8 at the Velcro and remove the diagonal belt.
3. Open the light-green belt holder 3 by pressing the button on the belt holder 3 backwards.
4. Take the diagonal belt out of the belt holder 3.
5. Press the locking button 7 and the release button 5 together and slide the ISOFIX locking arm 4 back into the bottom section of the seat.

ⓘ If the release button cannot be pressed, the ISOFIX locking arm is not locked in place. Pull the seat.

6. Slide the second ISOFIX locking arm 4 back into the bottom section of the seat.
- ✓ Both ISOFIX locking arms and the vehicle are protected against damage.

## 4.6 Secure child seat B2 (100 – 150 cm)

### 4.6.1 Prepare child seat

ⓘ This product is supplied with the configuration for fastening type A. If you want to use fastening type B, you have to change the fastening type (see "Changing the fastening type", page 22).

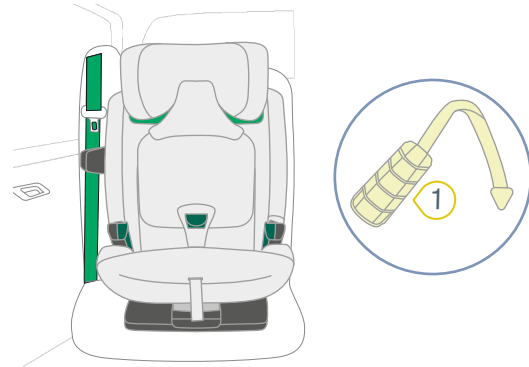

① XP-PAD

- ▶ Make sure that the child seat is ready for the fastening type B (see "Changing the fastening type", page 22).
- ▶ Fasten the XP-Pad 1 to the child seat ("XP-PAD").

### 4.6.2 Select seat

1. Select a suitable seat.
    - Car seats with i-Size approval are suitable.
- ⓘ In rare cases, the child seat on car seats with i-Size approval can only be adjusted within limits.
- Car seats with 3-point seat belt are suitable.
  - Only car seats arranged in the direction of travel are approved for use.

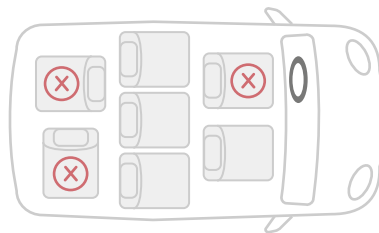

2. Note and observe the vehicle handbook.

ⓘ Britax Römer recommends positioning the car seats as follows.

#### When using on the front seat:

- ▶ Slide the front seat as far back as possible.

#### When using on the rear seat:

- ▶ Slide the back seat as far back as possible.
- ▶ Slide the front seat as far forwards as possible.

### 4.6.3 Position the seat

- ▶ Place the child seat on the car seat so that the backrest is flush to the backrest of the car seat.

ⓘ If the headrest of the car seat affects the fastening of the child seat, remove it (see vehicle handbook). Stow the removed headrest in a suitable location.

### 4.6.4 Secure SICT element

- ▶ Secure the SICT element (see "SICT", page 6).

### 4.6.5 Secure seat belt

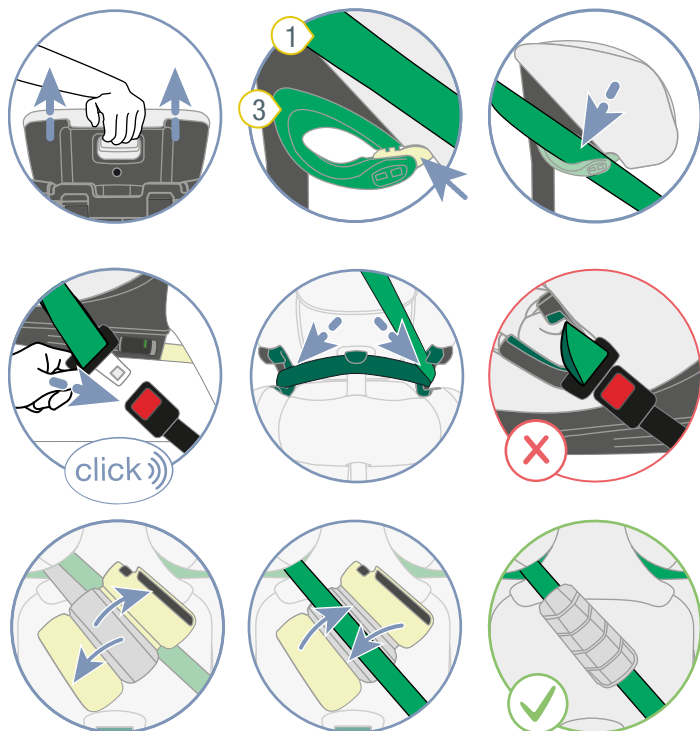
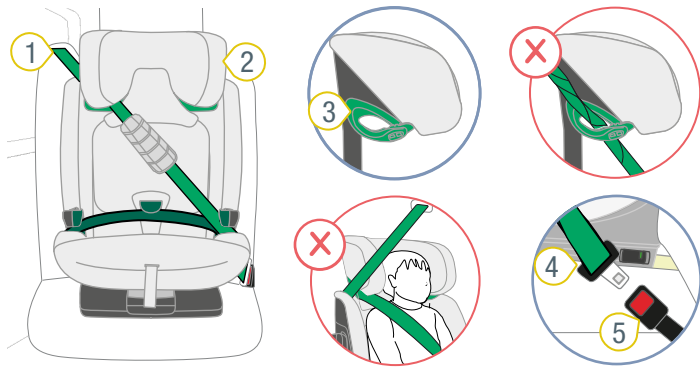

- ① Diagonal belt
- ② Headrest
- ③ Light-green belt holder
- ④ Buckle tongue
- ⑤ Seat belt lock

1. Set the headrest 2 to the highest position.
2. Open the light-green belt holder 3.
3. Pass the diagonal belt 1 through the light-green belt holder 3 of the headrest 2.

⚠ **WARNING** Risk of injury if belt fitted incorrectly. The diagonal belt must face away from the alignment of the child seat. Other belt routes impair the protective effect.

- ▶ Check the belt route.
- ▶ Make sure that diagonal belt faces against the direction of the child seat.
- ▶ Do **not** use the child seat on the car seat if the belt route faces forwards.

4. Engage the buckle tongue 4 in the seat belt lock 5.
5. Place the lap belt in both dark green belt guides.
6. Place the diagonal belt 1 on the side of the seat belt lock 5 into the dark green belt guide.

⚠ **WARNING** Risk of injury if forces are transferred incorrectly.

- ▶ Check the position of the seat belt lock.
- ▶ Do **not** use the child seat on the car seat if the seat belt lock is in the area of the dark green belt guide.

7. Undo the Velcro on the XP-PAD.
8. Fold the top part of the XP-PAD to the side.
9. Insert the diagonal belt 1 into the nubby surface of the XP-PAD.
10. Close the XP-PAD again by refolding the folded-back part and closing the Velcro.

### 4.7 Loosen child seat B2 (100 – 150 cm)

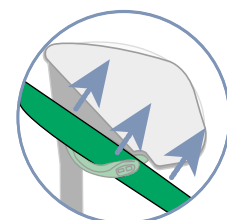
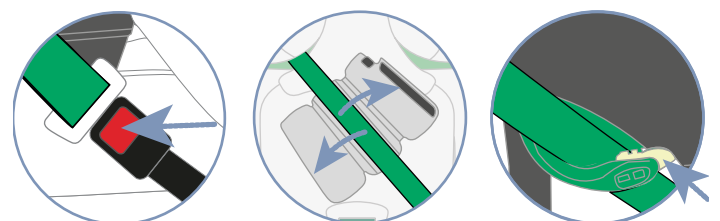
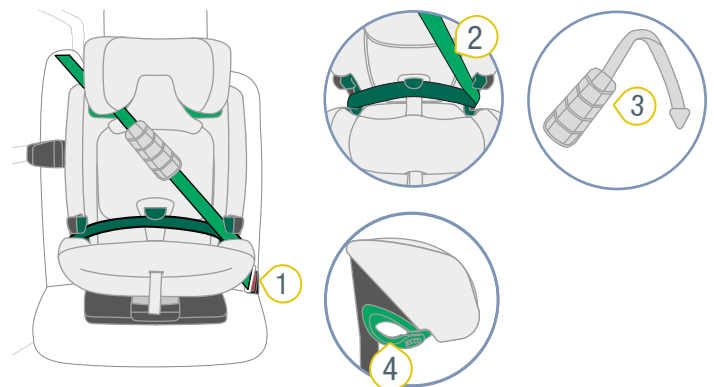

- ① Seat belt lock
- ② Diagonal belt
- ③ Light-green belt holder
- ④ XP-PAD

1. Release the 3-point seat belt by pressing the release button on the seat belt lock **1**.
2. Open the XP-PAD **4** at the Velcro and remove the diagonal belt **2**.
3. Open the light-green belt holder **3** by pressing the button on the belt holder backwards.
4. Take the diagonal belt **2** out of the belt holder **3**.

# 5 Buckling in and unbuckling

① Buckling in and unbuckling depend on the fastening type (see "Fastening type A and B", page 9).

## 5.1 Buckle child in A (76 – 105 cm)

### ⚠ WARNING

#### Risk of injury from slack straps

Slack straps are areas of the seat belt that lie loosely against the child's body. Slack straps have a negative impact on the protective function.

- ▶ Ensure that the straps are tight and not twisted.
- ▶ The child should not wear thick clothing under the belt.

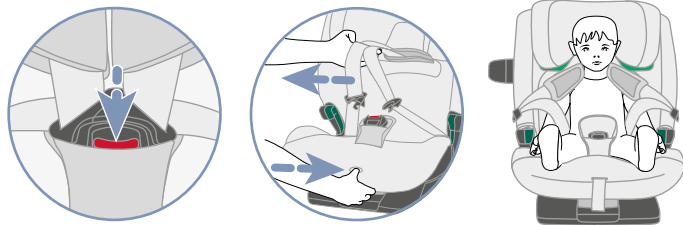
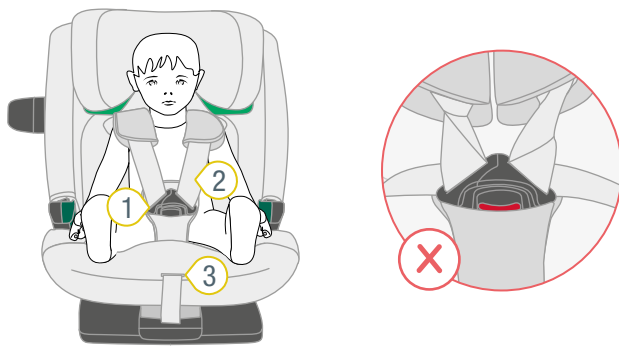

- ① Harness buckle
- ② Shoulder strap
- ③ Adjustment button

1. Make sure that the child seat is secure with fastening type A (see "Use in the vehicle", page 9).
2. To loosen the belt, press the adjustment button 3 and pull both shoulder straps 2 forwards at the same time.

① The shoulder pads are **not** connected to the shoulder straps. If you pull on the shoulder pads, the belt is **not** loosened. Only pull on the shoulder straps.

3. Open the harness buckle 1 by pressing the red button.
4. Place the harness buckle 1 at the front.
5. Never leave the child unsupervised in the seat.
6. Place the shoulder straps 2 over the child's shoulders.

⚠ **WARNING** Risk of injury if child is secured incorrectly. Make sure that the shoulder straps are not twisted or reversed.

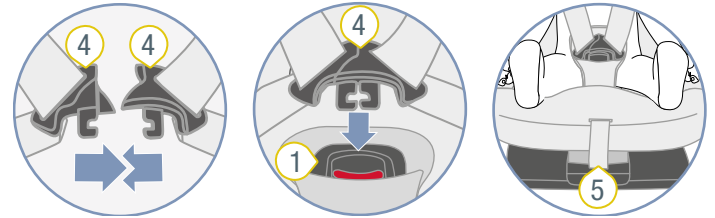

- ① Harness buckle
- ② buckle tongues
- ③ Adjustment belt

7. Bring the two buckle tongues 4 together.
  8. Insert the joined buckle tongues 4 into the harness buckle 1.
  - ✓ The buckle tongues 4 audibly lock in place.
  9. Pull at the adjustment belt 5 until the shoulder straps 2 are tight to the child's body.
- ⚠ **WARNING** Risk of injury to the abdomen (soft area in the stomach). Ensure that the hip straps are positioned as low as possible over your child's hips.

## 5.2 Check before every journey A (76 – 105 cm)

To protect your child, check the following points before each car journey.

1. The child seat and child are secured with fastening type A.
2. Both ISOFIX locking arms are locked into the ISOFIX installation brackets.
3. Both ISOFIX locking arms are extended the same distance.
4. Both ISOFIX indicators are green.
5. The TopTether is secured and taut.
6. A finger-width of the green indicator of the TopTether can be seen.
7. The SICT element is secured correctly.
8. The straps are tight to the child's body without restricting the child.
9. The headrest is correctly adjusted.
10. The shoulder pads are in the right position on the child.
11. The straps are **not** twisted and **not** reversed.
12. The child seat is used as intended in respect of the age and size of the child (see "Intended use", page 4).

## ⚠ WARNING

### Risk of injury due to omitted checks.

During the journey, the child may try to unbuckle the belt or loosen the child seat. If the child is not secured in the child seat, this can lead to serious or even fatal injuries.

#### If the child or the child seat is not fastened:

- ▶ Immediately stop the vehicle as soon as the traffic situation allows.
- ▶ Make sure that the child seat is secured.
- ▶ Ensure that the child is buckled in.

❗ For the wellbeing of your child, on long journeys Britax Römer recommends taking regular breaks. Give your child the opportunity to move.

## 5.3 Unbuckle child A (76 – 105 cm)

## ⚠ WARNING

### Risk of injury from unsecured objects

In the case of an emergency stop or accident, the unsecured child seat may cause injury to other occupants in the vehicle.

- ▶ Ensure that the child seat product is always secured when it is in the vehicle, even if no child is being transported.
- ▶ To unbuckle the child, press the red button on the harness buckle.
  - ❗ So that the child can get in easily before the next journey, loosen the shoulder straps.

## 5.4 Buckle child in B (100 – 150 cm)

## ⚠ WARNING

### Risk of injury from slack straps

Slack straps are areas of the seat belt that lie loosely against the child's body. Slack straps have a negative impact on the protective function.

- ▶ Ensure that the straps are tight and not twisted.
- ▶ The child should not wear thick clothing under the belt.

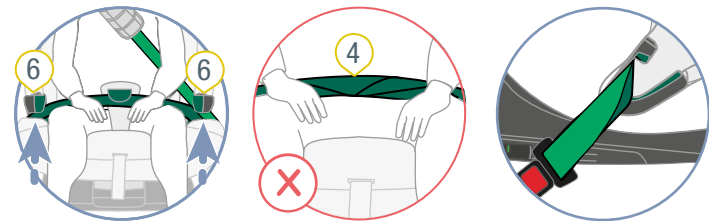
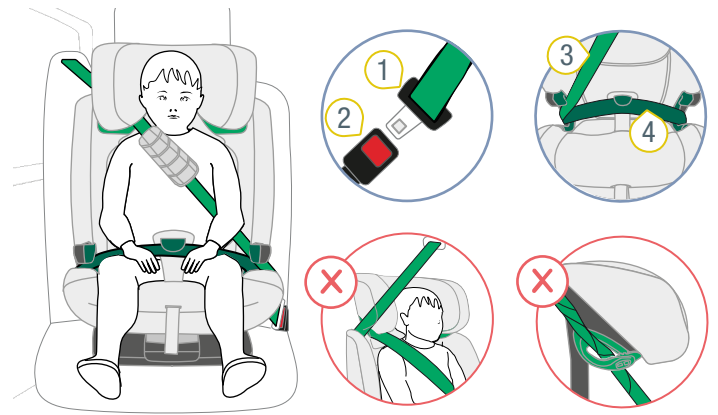

- |                  |                         |
|------------------|-------------------------|
| 1 Buckle tongue  | 4 Lap belt              |
| 2 Seat belt lock | 5 Dark green belt guide |
| 3 Diagonal belt  | 6 XP-PAD                |

1. Make sure that the child seat is secured with fastening type **B1** or **B2** (see "Use in the vehicle", page 9).
2. Leave space in the child for the child.
3. Engage the buckle tongue **1** in the seat belt buckle **2**.
4. Place the XP-PAD **6** over the chest area of the child.

❗ If you find that the retaining force of the 3-point seat belt is not enough to facilitate a taut belt route (lying on the child), the child seat can be used without XP-PAD.

5. Place the lap belt **4** into the two dark green belt guides **5**.
  - ⚠ **WARNING** Make sure that the lap belt is **not** twisted.
6. Place the diagonal belt **3** on the side of the seat belt lock **2** into the dark green belt guide **5**.
  - ⚠ **WARNING** Risk of injury to the abdomen (soft area in the stomach). Ensure that the lap belt is as low as possible over your child's hips.
7. Feed the lap belt **4** into the dark green belt Secure-Guard.

**▲ WARNING** Risk of injury due to incorrect fastening. **Do not** feed the diagonal belt into the dark green SecureGuard.

8. Tighten the seat belt by pulling on the diagonal belt **3**.

## 5.5 Check before every journey B (100 – 150 cm)

To protect your child, check the following points before each car journey.

1. The child seat and the child are secured either with fastening type **B1** or **B2**.
2. The SICT element is secured correctly.
3. The headrest is correctly adjusted.
4. The lap belt passes through both dark-green belt guides.
5. The lap belt is in the SecureGuard.
6. The diagonal belt is to the side of the seat belt lock in the dark-green belt guide.
7. The diagonal belt is in the light-green diagonal belt holder.
8. The button for the light-green belt holder is closed.
9. The diagonal belt is **not** in the SecureGuard.
10. The diagonal belt passes centrally over the child's collar bone
11. The diagonal belt does **not** pass over the child's neck.
12. The 3-point seat belt is **not** twisted.
13. The child seat is used as intended in respect of the age and size of the child (see "Intended use", page 4).

**Note the following as well when using fastening type B1:**

1. Both ISOFIX locking arms are locked into the ISOFIX installation brackets.
2. Both ISOFIX locking arms are in the same position.
3. Both ISOFIX indicators are green.

**Also note the following when using the XP-PAD:**

1. The XP-PAD is in the middle of the child's chest.
2. The tape of the XP-PAD is in the light-green belt holder.
3. The tape of the XP-PAD is not twisted.

## ▲ WARNING

**Risk of injury due to omitted checks.**

During the journey, the child may try to unbuckle the belt or loosen the child seat. If the child is not secured in the child seat, this can lead to serious or even fatal injuries.

**If the child or the child seat is not fastened:**

- ▶ Immediately stop the vehicle as soon as the traffic situation allows.
- ▶ Make sure that the child seat is secured.
- ▶ Ensure that the child is buckled in.

---

ⓘ For the wellbeing of your child, on long journeys Britax Römer recommends taking regular breaks. Give your child the opportunity to move.

---

## 5.6 Unbuckle child B (100 – 150 cm)

### ▲ WARNING

**Risk of injury from unsecured objects**

In the case of an emergency stop or accident, the unsecured child seat may cause injury to other occupants in the vehicle.

- ▶ Ensure that the child seat product is always secured when it is in the vehicle, even if no child is being transported.
- 
- ▶ To unbuckle the child, press the release button on the seat belt lock.



# 6 Changing the fastening type

## 6.1 Changing to fastening type B (100 – 150 cm)

**i** We recommend using fastening type A for as long as possible. Only use fastening type B when your child is bigger than 105 cm.

### 6.1.1 Preparing the change

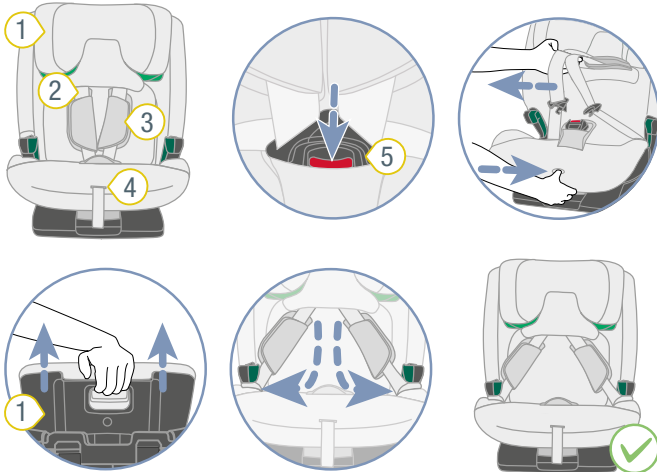

- ① Headrest
- ② Shoulder strap
- ③ Shoulder pads
- ④ Adjustment button
- ⑤ Harness buckle

1. Open the harness buckle 5.
2. To loosen the belt, press the adjustment button 4 and pull both shoulder straps 2 forwards at the same time.

**i** The shoulder pads are **not** connected to the shoulder straps. If you pull on the shoulder pads, the belt is **not** loosened. Only pull on the shoulder straps.

3. Extend the headrest 1 to its maximum.
4. Place the buckle tongue in the dark green belt guides.

### 6.1.2 Loosen shoulder straps from the headrest.

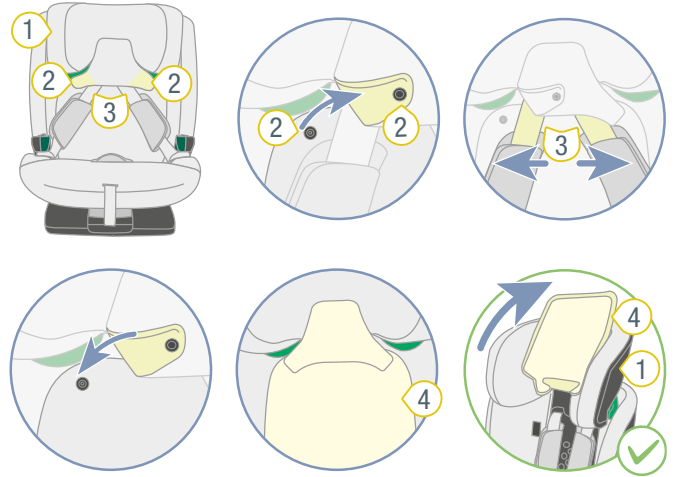

- ① Headrest
- ② Push-buttons
- ③ Shoulder straps
- ④ Cover of the headrest

1. Loosen the push-buttons 2.
2. Detach the shoulder straps 3 from the cover the headrest 4.
3. Close the push-buttons 2.
4. Fold the cover of the headrest 4 up.



### 6.1.3 Stow 5-point seat belt

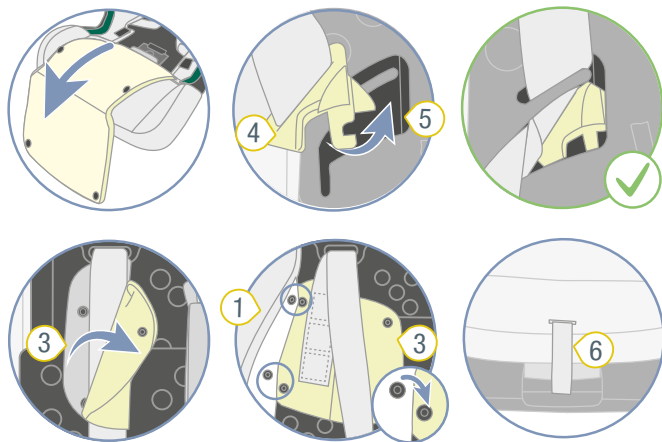
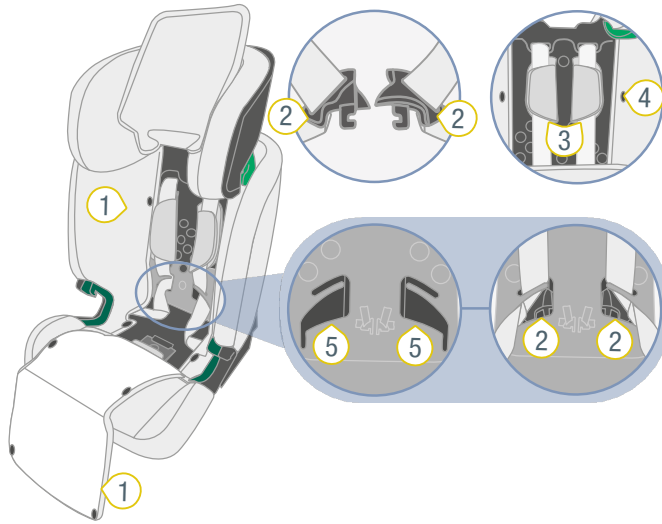

- ① Cover
- ② Buckle tongue
- ③ Shoulder pads
- ④ Push button
- ⑤ Recess
- ⑥ Adjustment belt

1. Pull the cover 1 forwards.
- INFO** The cover 1 is fastened with press buttons.
2. Place the buckle tongues 2 into the recesses 5.
  3. Open the two shoulder pads 3.
  4. Slide the shoulder pads 3 under the cover the backrest.
  5. Secure the shoulder pads 3 under the cover of the backrest with the push-buttons 4.
  6. Tighten the harness by pulling on the adjustment belt 6.

### 6.1.4 Fasten SecureGuard

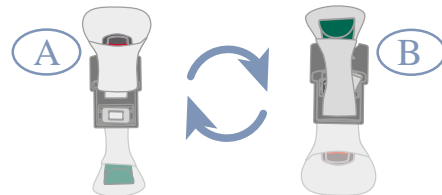
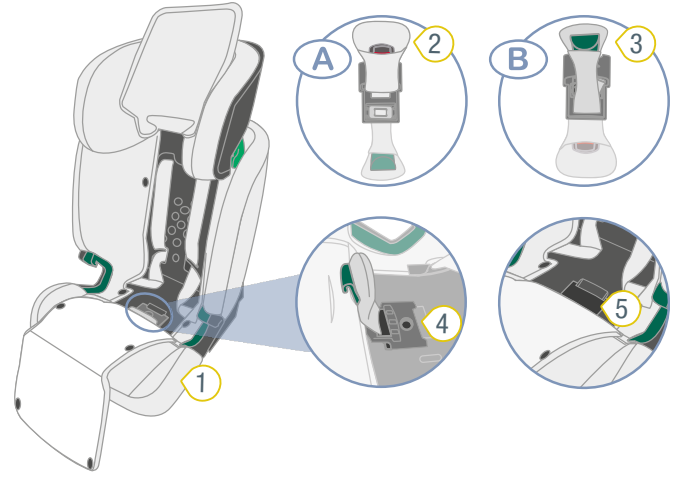

- ① Cover
- ② Harness buckle
- ③ SecureGuard
- ④ Grey removable disc
- ⑤ Recess

1. Remove the cover 1 from the harness buckle 2.
  2. Lift the grey removable disc 4 and slide it with the harness buckle 3 out towards the backrest.
  3. Turn over the grey removable disc 4.
- ✓ The SecureGuard 3 is up and the harness buckle 2 down.

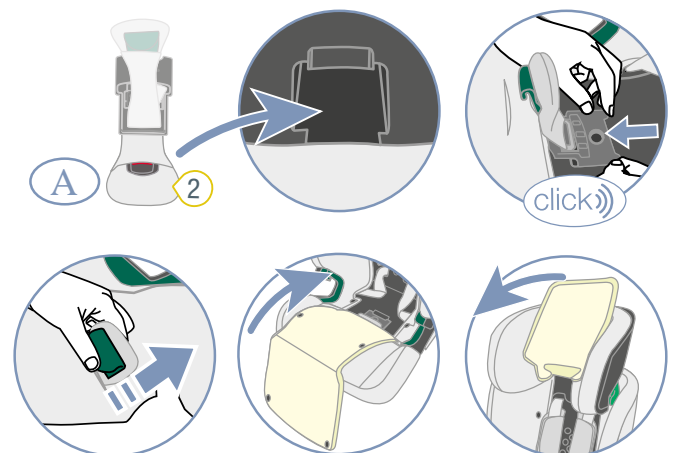

- ② Harness buckle
4. Stow the harness buckle 2 in the recess 5.
  5. Slide the grey removable disc 4 back into its holder.
- ✓ The grey removable disc 4 locks audibly in place.

6. Thread the SecureGuard 3 through the slot in the cover with the spacer B.
7. Fold back the cover 1.
8. Close the press buttons of the cover 1.
9. Fold down the cover of the headrest.

① The headrest can be set to a body size of up to 125 cm. To use the range from 125 – 150 cm, press this (see "Unlock upper area", page 5).

## 6.2 Changing to fastening type A (76 – 105 cm)

### 6.2.1 Press switch

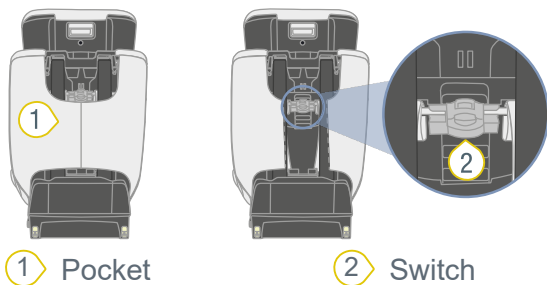

① The switch is located behind the pocket 1.

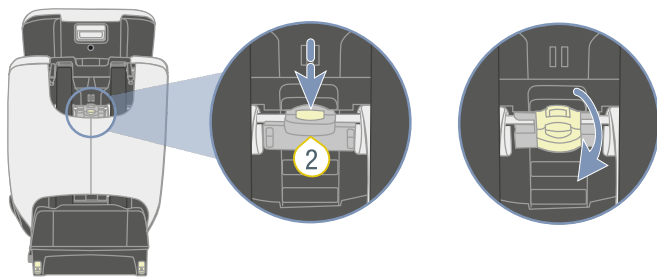

1. Extend the headrest to its maximum.
  2. Keep holding the button on the switch 3 depressed.
  3. Tilt the switch 3 down.
- ✓ Switch 3 is locked in the lower position.

### 6.2.2 Preparing the change

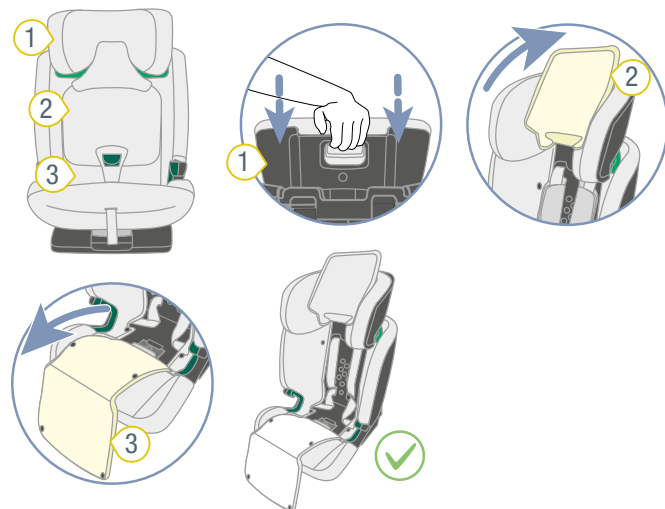

- ① Headrest
- ② Cover of the headrest
- ③ Cover

1. Slide the headrest 1 to the lowest position.
2. Fold the cover of the headrest 2 up.
3. Pull the cover 3 forwards.

**INFO** The cover 1 is fastened with press buttons.

### 6.2.3 Attach harness buckle

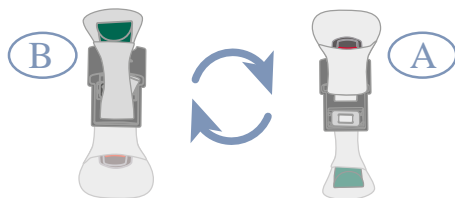
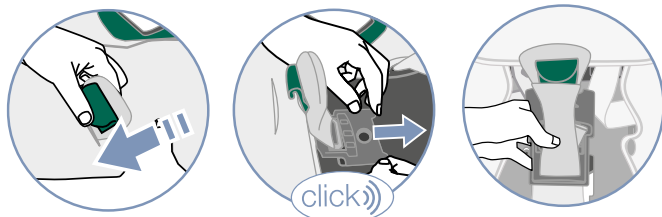
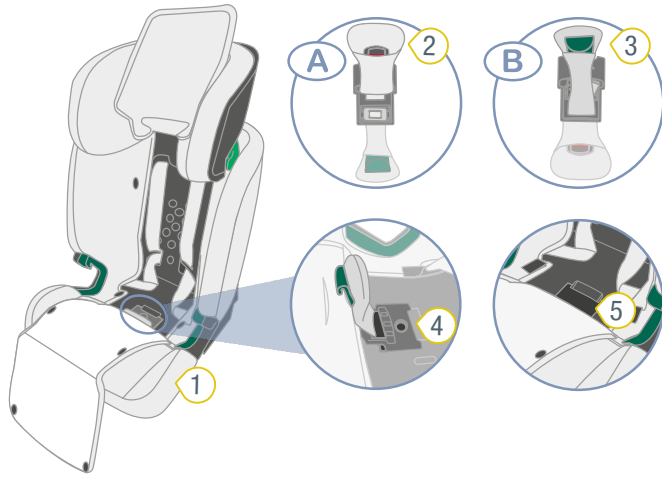

- ① Cover
- ② Harness buckle
- ③ SecureGuard
- ④ Grey removable disc
- ⑤ Recess

1. Detach the cover 1 from the SecureGuard 3.
2. Lift the grey removable disc 4 and slide it with the SecureGuard 3 out towards the backrest.
3. Turn over the grey removable disc 4.
- ✓ The harness buckle 2 is up and the SecureGuard 3 down.

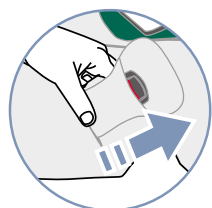
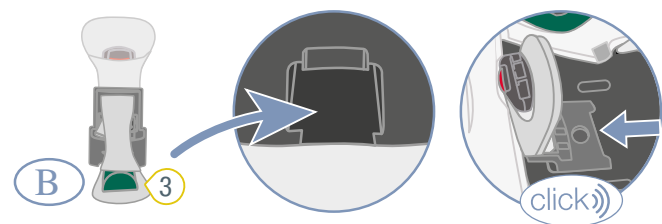

4. Stow the SecureGuard 3 in the recess 5.
5. Slide the grey removable disc 4 back into its holder.
- ✓ The grey removable disc 4 locks audibly in place.

6. Thread the harness buckle 2 through the rear slot in the cover 1.

ⓘ Do not use the slot in the cover with the spacer B.

### 6.2.4 Attach 5-point harness

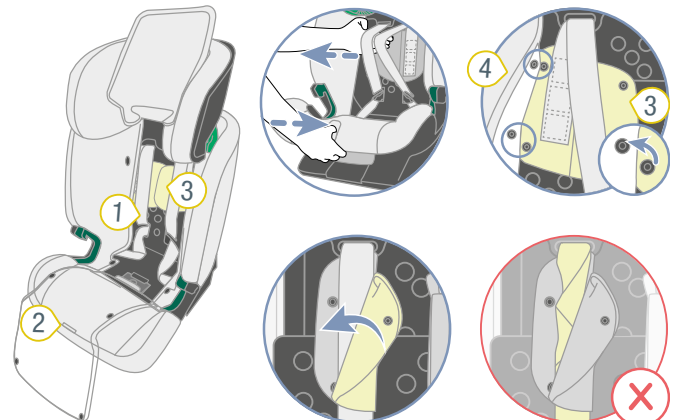

- ① Harness
- ② Adjustment button
- ③ Shoulder pads
- ④ Cover

1. To loosen the belt 1, press the adjustment button 2 and pull the two shoulder straps forwards at the same time.

ⓘ The shoulder pads are **not** connected to the shoulder straps. If you pull on the shoulder pads, the belt is **not** loosened. Only pull on the shoulder straps.

2. Remove the two shoulder pads 3 from the cover 4 of the backrest.
3. Close the two shoulder pads 3.

#### ⚠ WARNING

► Make sure that the shoulder straps are threaded correctly through the shoulder pads.

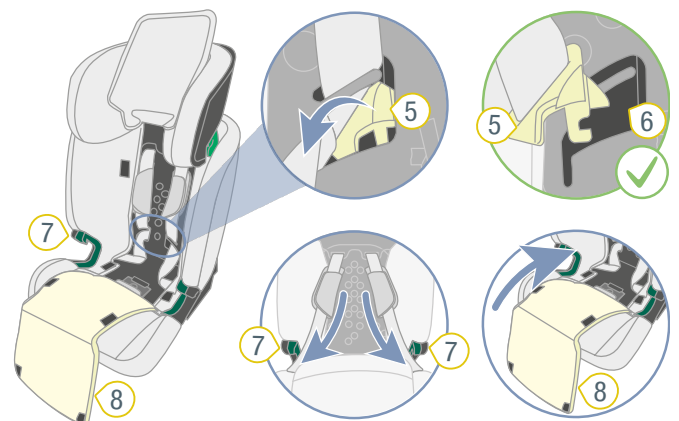

4. Remove the buckle tongues 5 from their recess 6 on the inside section of the buckle tongue.
5. Insert the buckle tongues 5 into the dark green belt guides 7.
6. Fold back the cover 8.
7. Close the press buttons of the cover 8.

## 6.2.5 Connect shoulder straps with the headrest.

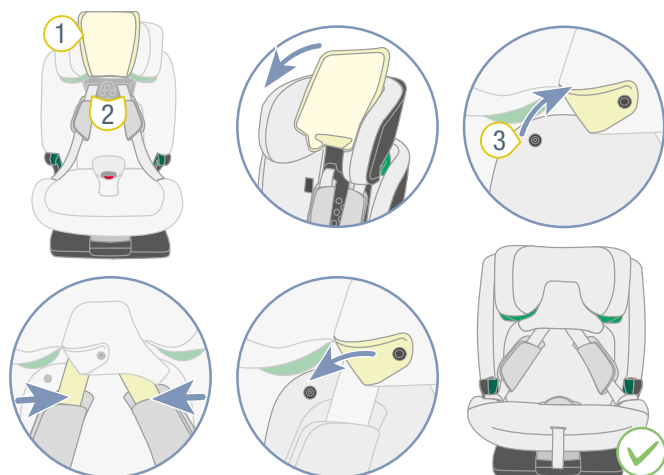

- ① Cover of the headrest  
② Shoulder straps  
③ Push-buttons

1. Fold down the cover of the headrest 1.
2. Loosen the push-buttons 3.
3. Place the shoulder straps 2 into the slots of the headrest.
4. Close the push-buttons 3.

# 7 Cleaning and maintenance

## 7.1 Harness buckle

### 7.1.1 Remove harness buckle

#### Preparation

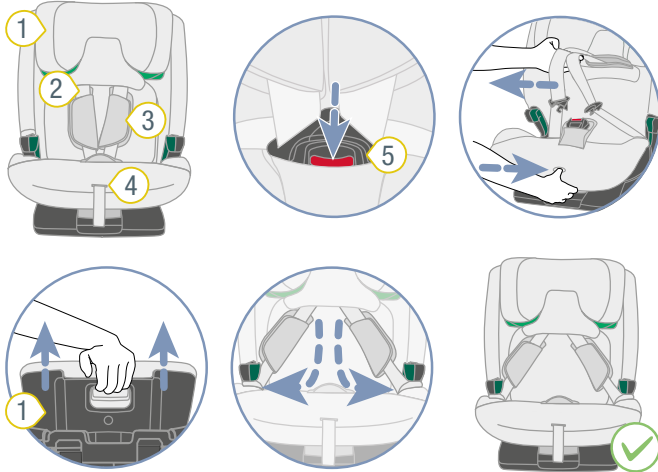

- ① Headrest
- ② Shoulder strap
- ③ Shoulder pads
- ④ Adjustment button
- ⑤ Harness buckle

1. Open the harness buckle 5.
2. To loosen the belt, press the adjustment button 4 and pull both shoulder straps 2 forwards at the same time.

ⓘ The shoulder pads are **not** connected to the shoulder straps. If you pull on the shoulder pads, the belt is **not** loosened. Only pull on the shoulder straps.

3. Extend the headrest 1 to its maximum.
4. Place the buckle tongues in the lateral belt guides.

#### Remove harness buckle

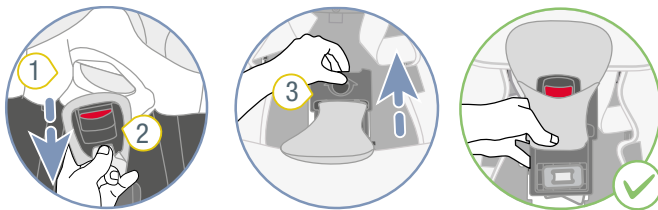

- ① Cover
- ② Harness buckle
- ③ Removable disc

1. Remove the cover 1 from the harness buckle 2.
2. Lift the grey removable disc 3 and slide it with the harness buckle 2 out towards the backrest.

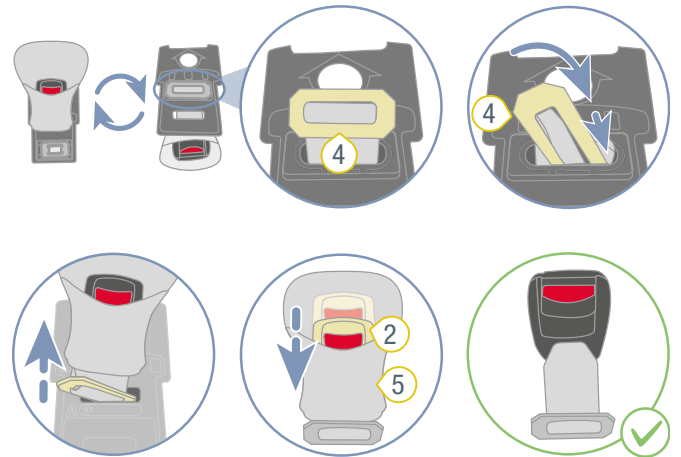

- ② Harness buckle
- ③ Metal plate
- ④ Metal plate
- ⑤ Cover

3. Turn over the grey removable disc 3.
4. Thread the metal plate 4 through the cover.
5. Remove the cover 5 from the harness buckle 2.

### 7.1.2 Clean belt lock

1. Soak the belt lock for at least an hour. Use warm water with washing-up liquid.
2. Thoroughly rinse and dry the harness buckle.

### 7.1.3 Attach harness buckle

#### Attach harness buckle to the removable disc

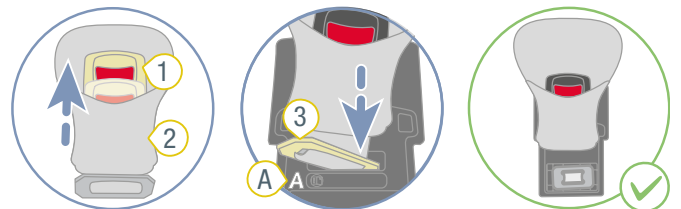

- ① Harness buckle
- ② Cover
- ③ Metal plate

1. Thread the metal plate 3 through the cover 2.



- Thread the metal plate **3** through the slot **A** of the grey removable disc.

**⚠ WARNING**

**Risk of injury from unsecured harness buckle**

The harness buckle is an integral safety component of the child seat. If the harness buckle is not secured correctly, this may lead to serious or even fatal injuries.

- Make sure that the red button **4** faces the indentation.
- Make sure that the metal plate **3** is in the recess.
- Make sure that the harness buckle is securely fastened to the grey removable disc by forcefully pulling at the harness buckle.

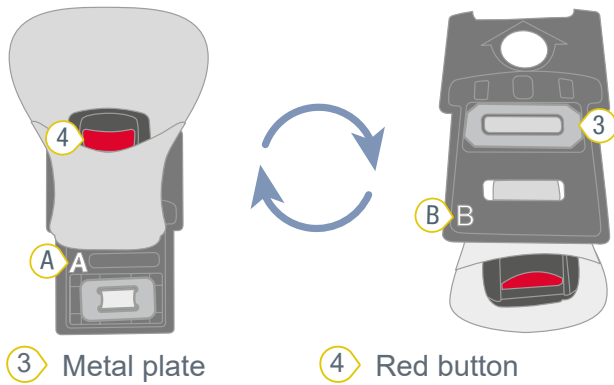

**Fasten removable disc**

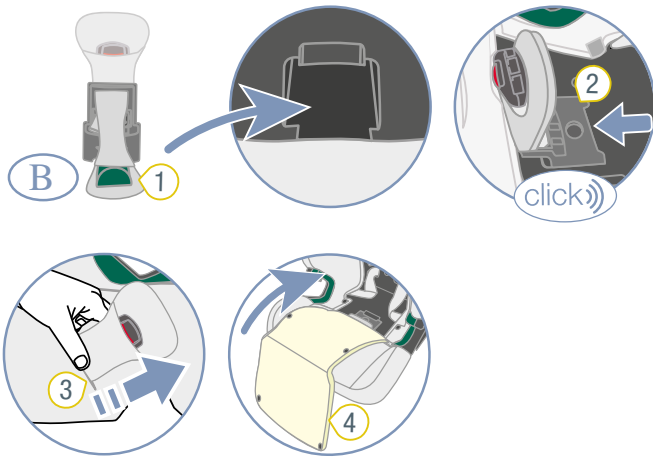

- 1** SecureGuard      **3** Harness buckle
- 2** Grey removable disc      **4** Cover

- Stow the SecureGuard **1** in the recess.
- Slide the grey removable disc **2** back into its holder.  
✓ The grey removable disc **2** locks audibly in place.
- Thread the harness buckle **3** through the rear slot in the cover **4**.
- Fold back the cover **4**.
- Close the press buttons of the cover **4**.

**7.2 Cover**

**⚠ WARNING**

**Risk of injury due to missing parts**

A secure hold is no longer guaranteed.

- ▶ The product must not be used without the seat cover.

**7.2.1 Remove cover from the headrest**

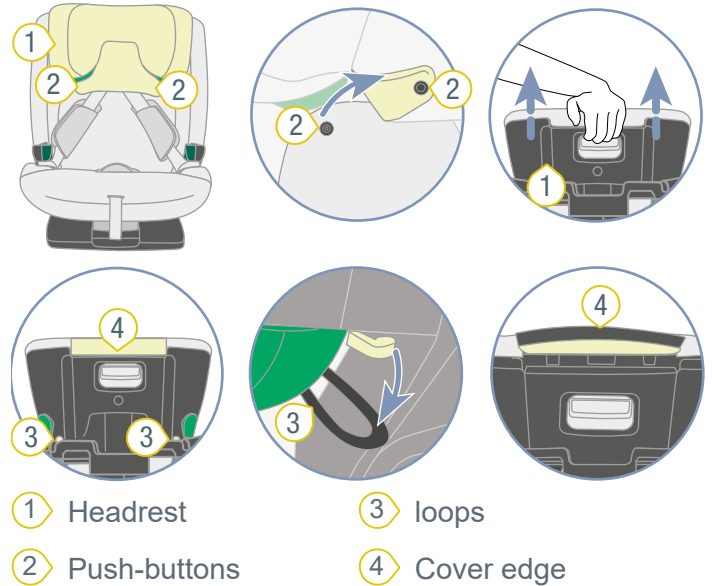

- Open the two push-buttons **2**.
- Extend the headrest **1** to its maximum.
- Loosen the loops **3**.
- Pull off the cover from the headrest **1**.
- Pull up the cover edge **4**.

**7.2.2 Remove cover from the seat**

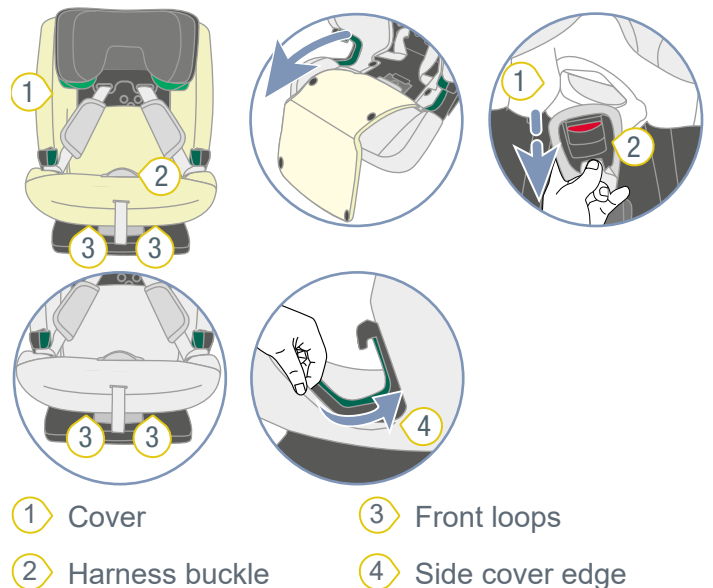

1. Pull the cover **1** forwards.  
**INFO** The cover **1** is fastened with press buttons.
2. Remove the cover **1** from the harness buckle **2**.
3. Loosen the front loops **3**.
4. Loosen the side cover edges **4**.
5. Pull the cover **1** up and off.

### 7.2.3 Clean cover

- i** You can remove the following covers and wash them in the washing machine:
- ▶ Cover of the headrest.
  - ▶ Seat cover.
  - ▶ Cover of harness buckle.
  - ▶ Cover of the SecureGuard.
- 
- ▶ Note the instructions on the cover's washing label.
  - ▶ Wash the cover at 30 °C with a mild detergent on the washing machine's fine wash programme.
  - ▶ You can remove the shoulder pads and wash them with like warm soapy water.
  - ▶ You can clean the plastic parts and straps with soapy water.
  - ▶ Do not use strong cleaning agents (such as solvents).

### 7.2.4 Attach cover

#### **⚠ WARNING**

##### Risk of injury due to missing seat cover

The seat cover is an integral safety component of the child seat. If the seat cover is not used, this may lead to serious or even fatal injuries.

- ▶ Never use the child seat without the correct seat cover.
- ▶ Only use the original Britax Römer replacement seat cover.
- ▶ Replacement seat covers are available from your retailer.

- ▶ To fit the cover again, follow the steps in the reverse order.

#### **⚠ WARNING**

##### Risk of injury due to twisted straps.

Twisted straps have a negative impact on the protective function.

- ▶ Ensure that the straps are tight and not twisted.
- ▶ Ensure that the straps are fitted correctly in the belt slots of the cover.

## 7.3 Shoulder pads

### 7.3.1 Remove shoulder pads

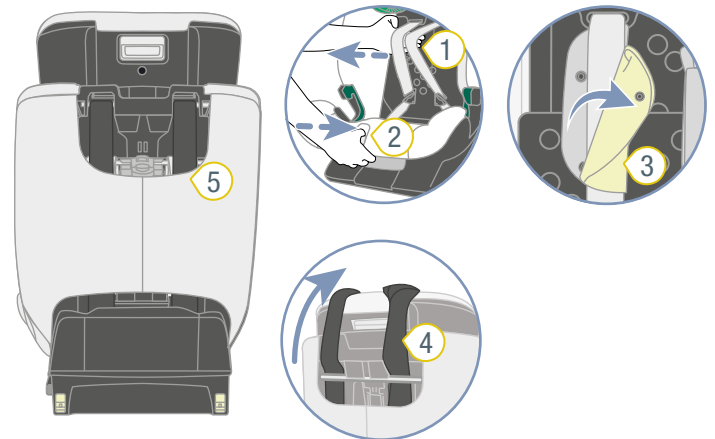

- 1** Shoulder straps
- 2** Adjustment button
- 3** Shoulder pads
- 4** TopTether
- 5** Pocket

1. Loosen the child seat (see "Loosen child seat A (76 – 105 cm)", page 12).
2. To loosen the belt, press the adjustment button **2** and pull both shoulder straps **1** forwards at the same time.

**i** The shoulder pads are **not** connected to the shoulder straps. If you pull on the shoulder pads, the belt is **not** loosened. Only pull on the shoulder straps.

3. Open the two shoulder pads **3**.
4. Place the TopTether **4** forwards above the seat.
5. Unhook the pocket **5** up and off.

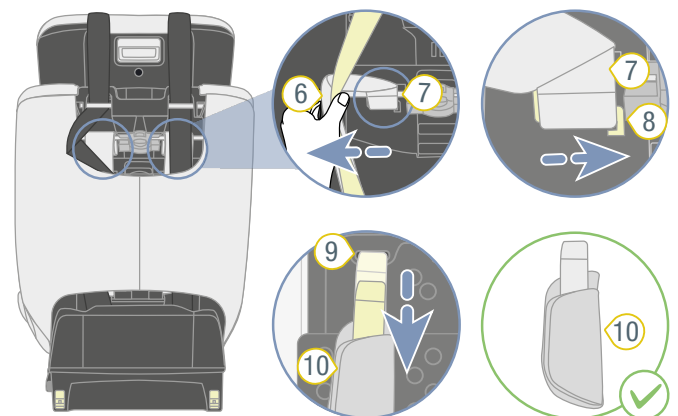

- 6** Shoulder strap
- 7** Belt loop
- 8** Plastic web
- 9** Belt slot
- 10** Shoulder pads

6. Extend the shoulder straps **6** slightly so that you can see the belt loops **7** of the shoulder pads **10** underneath.
7. Unhook the belt loops **7** from the plastic web **8**.
8. Pull the shoulder pads **10** forwards out of the belt slots **9**.



### 7.3.2 Attach shoulder pads

#### **⚠ WARNING**

##### **Risk of injury due to missing shoulder pads.**

The shoulder pads are an integral safety component of the child seat. If the shoulder pads are not used, this may lead to serious or even fatal injuries.

- ▶ Never use the child seat without the correct shoulder pads.
- ▶ Only use the original Britax Römer shoulder pads.

- 
- ▶ To fit the shoulder pads again, follow the steps in the reverse order.

#### **⚠ WARNING**

##### **Risk of injury due to twisted shoulder pads**

Twisted straps have a negative impact on the protective function.

- ▶ Make sure that the shoulder pads and straps are not twisted or reversed.
- ▶ Ensure that the shoulder straps in the shoulder pads are positioned beneath the edge of the cover.

## 7.4 Troubleshooting

### **Harness buckle**

The harness buckle is an integral part of the child seat and fulfils important functions for securing the child. Make sure that the harness buckle works perfectly.

#### **Possible problems:**

- The buckle tongues are only pushed out of slowly after pressing the red unlocking button.
- The buckle tongues no longer lock in place.
- The buckle tongues lock in place but not audibly.
- The buckle tongues can only be pushed into the harness buckle with difficulty.
- It takes a lot of force to open the harness buckle.

#### **Solution:**

- ▶ Clean the harness buckle (see "Clean belt lock", page 27).

### **ISOFIX connection**

The ISOFIX connection is an integral part of the child seat and fulfils important functions of the child seat. Make sure that the ISOFIX connection works perfectly.

#### **Possible problem:**

- The ISOFIX locking arms of the child seat cannot be connected to the ISOFIX installation brackets of the vehicle.

#### **Solution:**

- ▶ Clean the vehicle's ISOFIX installation bracket.

# 8 Storage and disposal

---

## 8.1 Storage

If you do not use the product for a longer period, please note the following information.

- ▶ Store product in a secure and dry location.
- ▶ Keep the storage temperature between 20 and 25 °C.
- ▶ Do not lean heavy objects on the product.
- ▶ Do not store product directly next to sources of heat or in direct sunlight.
- ▶ Protect the product from moisture, wet conditions, liquids, dust and salt spray.

## 8.2 Disposal

- ▶ Do not dismantle the product.
- ▶ Prevent third parties from using the defective product.
  - ▶  Cut through the shoulder straps.  
Remove the approved label.
- ▶ Please follow the disposal regulations applying in your country.

## 9 Contact

---

If there are any questions, please get in touch:

BRITAX RÖMER Child Safety EMEA

[www.britax-roemer.com](http://www.britax-roemer.com)

[contact@britax.com](mailto:contact@britax.com)

BRITAX RÖMER Kindersicherheit GmbH

Theodor-Heuss-Strasse 9

89340 Leipheim

Germany